

**EAST GOSHEN TOWNSHIP
PLANNING COMMISSION
Meeting Agenda
Wednesday, October 5, 2022
7:00 PM**

- A. Call to Order / Pledge of Allegiance and Moment of Silence
- B. Chairman will ask if anyone is going to record the meeting
- C. Review of Tracking Log / Determine need for Workshop Meeting
- D. Public Comment on Non-Agenda Items
- E. **Approval of Minutes**
 - 1. **August 2, 2022**
 - 2. **September 7, 2022**
- F. **Subdivision and Land Development Applications**
 - 1. **14 Reservoir Road Residential Subdivision (Initial Submission)**
- G. Conditional Uses and Variances
 - 1. **Miller Property Residential Subdivision (Presentation)**
- H. Ordinance Amendments
 - 1. **Noise Ordinance Standards in Zoning Ordinance (Initial Submission)**
- I. Old Business
 - 1. **Applebrook Golf Club Turf Maintenance Area – Update – No Action Required**
 - a. Township Engineer completed his review and provided a letter dated 9-1-2022
 - b. Chester County PC completed their review and provided a letter dated 9-21-2022
 - c. Chester Valley Engineers checked pipeline distance and the lower portion is within 660 feet. They will work on providing a pipeline assessment study.
 - d. The legal aspects continue to be evaluated and completed.
- J. New Business
- K. Liaison Reports
- L. Correspondence
- M. Announcements

Bold Items indicate new information to review or discuss.

Draft
EAST GOSHEN TOWNSHIP
PLANNING COMMISSION MEETING
August 3, 2022

The East Goshen Township Planning Commission held their regular monthly meeting on Wednesday August 3, 2022 in the Township Building.

Members present are highlighted:

Chair – Ernest Harkness

Vice Chair – John Stipe

Dan Daley

Edward Decker

Michael Koza

Mark Levy

Michael Pagnanelli

Also present was:

Duane Brady, Zoning Officer

Derek Davis, Township Manager

COMMON ACRONYMS:

BOS – Board of Supervisors

BC – Brandywine Conservancy

CB – Conservancy Board

CCPC – Chester Co Planning Commission

CPTF – Comprehensive Plan Task Force

CVS – Community Visioning Session

SWM – Storm Water Management

ZHB – Zoning Hearing Board

FORMAL MEETING – 7 p.m.

1. Ernest called the meeting to order at 7:00 pm. He led the Pledge of Allegiance and asked for a moment of silence to remember our troops and first responders.
2. Ernest asked if anyone would be recording the meeting and if there were any public comments about non-agenda items. There was no response.
3. The tracking log was checked and no need for a workshop meeting.
4. The minutes of the June 1, 2022 meeting were approved.
5. Ernest introduced Duane J. Brady, East Goshen’s new Zoning Officer. Duane reviewed his past experience and positions.

SUBDIVISION AND LAND DEVELOPMENT APPLICATIONS

1. Applebrook Golf Club - Two representatives for Applebrook were present. They provided a map that showed the location of the proposed buildings. The buildings will provide more space for their lawn maintenance equipment and supplies. It will be a better facility to wash their equipment and store the fuels they need. The large gray box on the plan is the first building they want to build. The small yellow box is for a future extension when they get an easement to that corner of the property. This is a complicated plan. There are legal issues that have to be worked out. This is just a preliminary presentation. It has not been reviewed by the Township Staff for zoning issues. They are putting a complete packet together. Their attorney is working with Township and County solicitors. Ernest thanked them for coming and asked that they provide a complete packet for the September meeting.

OLD BUSINESS

Paoli Pike Trail (Alternate Route Alignment) – Derek explained that the BOS wants input from the PC about the proposed alternate route for the Paoli Pike trail Segment B. He reviewed the proposed alternate route through and/or around the Goshen Corporate Park. There are 5 parts to this proposed route. #1

1 goes though the Park along Enterprise Drive. #2 goes along Paoli Pike and turns to go along the side of
2 the Corporate Park. #3 continues through the Corporate Park. #4 goes through a wetland and would
3 require a boardwalk. #5 goes behind properties on Linden Lane and a small section is on Hicks property.
4 He reviewed a chart showing the cost estimates for the different sections. There was discussion about
5 getting easements from the companies in the corporate park. Dan spoke about possibly crossing Paoli
6 Pike by extending #2 to the creek, cross over and go along the school property to Airport Road. Then
7 continue up Airport Road to link in with the YMCA. Derek mentioned that the thought for #1 is to stripe
8 Enterprise Drive to make a walkway. West Goshen has not worked on a trail plan yet. They will
9 probably use Ward Ave. because they can't go along Paoli Pike in West Goshen. There was discussion
10 about doing #1 & #2 now, so people can ride bikes/walk this loop and get back onto Paoli Pike. Ernest
11 summarized as follows:

- 12 1. Tie in with the School and YMCA
 - 13 2. #2
 - 14 3. #3 and #5 are advantageous
 - 15 4. #1 put this in the loop with #2
- 16 Derek will prepare a memo for the BOS meeting.

17
18 **NEW BUSINESS** - None

19
20 **LIAISON REPORTS** - None

21
22 **CORRESPONDENCE** - None

23
24 **ADJOURNMENT**

25 There being no further business, the meeting was adjourned at 9:00 pm. The next regular meeting will be
26 held on Wednesday, September 7, 2022 at 7:00 pm.

27
28
29 Respectfully submitted,

30
31
32
33
34

Ruth Kiefer, Recording Secretary

35

Draft
EAST GOSHEN TOWNSHIP
PLANNING COMMISSION MEETING
September 7, 2022

The East Goshen Township Planning Commission held their regular monthly meeting on Wednesday September 7, 2022 in the Township Building.

Members present are highlighted:

Chair – Ernest Harkness

Vice Chair – John Stipe

Dan Daley

Edward Decker

Michael Koza

Mark Levy

Michael Pagnanelli

Also present was:

Duane Brady, Zoning Officer

Derek Davis, Township Manager

Nathan Cline, Township Engineer

COMMON ACRONYMS:

BOS – Board of Supervisors

BC – Brandywine Conservancy

CB – Conservancy Board

CCPC – Chester Co Planning Commission

CPTF – Comprehensive Plan Task Force

CVS – Community Visioning Session

SWM – Storm Water Management

ZHB – Zoning Hearing Board

FORMAL MEETING – 7 p.m.

1. Ernest called the meeting to order at 7:00 pm. He led the Pledge of Allegiance and asked for a moment of silence to remember our troops and first responders.
2. Ernest asked if anyone would be recording the meeting and if there were any public comments about non-agenda items. There was no response.
3. The tracking log was checked and no need for a workshop meeting.
4. The minutes of the August 3, 2022 meeting could not be approved since there was not a quorum.

SUBDIVISION AND LAND DEVELOPMENT APPLICATIONS

I. Applebrook Golf Club - Jared Viarengo, Applebrook Golf Club Director of Grounds and Bret MacKay, Chester Valley Engineer were present. Mr. MacKay mentioned that the rendering they were providing is clearer but essentially the same as what they presented at last month's meeting. They are showing building elevations. The new buildings will have higher ceilings up to 16 feet. Mr. Cline will check but feels the height is within zoning requirements. Mr. Viarengo explained how they store and maintain their equipment. They plan to have new specialized equipment that will recycle water when they wash their mowing machines. They currently have an above ground fuel tank and want to upgrade to today's standards. Mr. Viarengo mentioned that their attorney is working with the Township Solicitor on legal issues concerning the fact that these buildings are on East Goshen Township land and Applebrook has an easement with East Goshen Township to use this property. They are planning to have a solution for the October meeting. Mr. Daley asked about variances. Mr. Cline commented that they still need to be resolved. This could go to the Zoning Hearing Board. Mr. Harkness pointed out that the Pennoni letter mentioned their existing water service. Mr. Viarengo commented that their water service is from a well. They are on public sewer with a grinder pump. Mr. Harkness mentioned that under a new ordinance (205.40-1) a pipeline awareness study may be needed. Mr. Cline will check on this.

1
2
3 **CONDITIONAL USES AND VARIANCES**

4 1. Miller Property Residential Subdivision for 1010 Hershey Mill Road. This proposal is to subdivide
5 and develop an existing tract of land with 15 single-family residential lots. Mr. Cline commented that
6 they have had discussions with the developer. This is the first formal open space cluster development. He
7 explained how they will meet open space requirements, and public sewer and water. He will be
8 reviewing the plan to go deeper into the zoning code. Residents within 1,000 feet will have to be notified
9 of meetings. He will check to see if a pipeline awareness study is needed. There is a storm water basin
10 behind the property which is an easement for East Goshen Township. Mr. Brady explained the
11 breakdown in the ordinance. He will get a letter from the owner and developer. He will do a review for
12 fire services.
13

14
15 **ORDINANCE AMENDMENTS**

16 1. Zoning “Catch-All” provision – This was added to the agenda. Mr. Davis explained that essentially,
17 all legal uses within the Commonwealth must be allowed within at least one zoning district in any
18 municipality. He is asking the Commission members to look at zoning districts that would be appropriate
19 for adding a “catch-all” provision. He and the Township Solicitor have reviewed this and feel that the I-1
20 Light Industrial District (located off of Airport Road above the YMCA and extending up to Wilson
21 Drive) makes the most sense for this provision based on what is currently there today. Also, they need an
22 area with some open parcels. Since the Planning Commission did not have a quorum, they could not give
23 an official recommendation to the Board of Supervisors for the upcoming hearing.

24 The following are comments from the three members:

- 25 1. Mr. Daley’s main concern was about the consequences of specific open pieces of land in
26 the I-1 zoning district where the catch-all would be located since there are some houses
27 (Linden Lane) very close to an open parcel on Goshen Parkway within the I-1. Mr. Davis
28 commented that he understands what Mr. Daley is looking at but that currently there is
29 concern throughout the township in many different locations since a catch-all doesn’t
30 exist.
- 31 2. Mr. Harkness - While he saw no issue with the proposal, he also didn’t think it was a
32 necessary thing to pass. He asked about the following language in Section 1 of the
33 proposed ordinance: “Any lawful use not otherwise permitted in the Township”. He
34 thought there was probably a more straightforward way to word that phrase such as,
35 “Any lawful uses currently not defined in the township zoning code.” He verified that
36 this would be a Conditional Use.
- 37 3. Mr. Koza asked a question concerning the overall intent of the provision just so he would
38 understand it more, but he did not see an issue with putting the provision in the Zoning
39 Ordinance. Mr. Davis commented that it is something we have to put in, but he hopes we
40 never have to use.

41
42 **OLD BUSINESS** - None

43
44
45 **NEW BUSINESS** - None

46
47
48 **LIAISON REPORTS** – None

1 **CORRESPONDENCE** - None

2

3

4 **ADJOURNMENT**

5 There being no further business, the meeting was adjourned at 8:00 pm. The next regular
6 meeting will be held on Wednesday, October 5, 2022 at 7:00 pm.

7

8

9 Respectfully submitted,

10

11

12

13

14

Ruth Kiefer, Recording Secretary

15

Memorandum

East Goshen Township
1580 Paoli Pike
West Chester, PA 19380

Voice: 610-692-7171
Fax: 610-692-8950
E-mail: dbradv@eastgoshen.org

Date: 9-28-2022
To: Planning Commission
From: Duane J. Brady Sr., Zoning Officer
Re: 14 Reservoir Road SD / Residential Lot

Dear Commissioners,

The Township staff has received a SD application for 14 Reservoir Road. The proposal is to create a second residential lot on the existing property. The application has been reviewed for completeness and was accepted by Township Staff on September 28, 2022.

Background Information:

- Existing single-family residential lot on 2-acre lot is to be subdivided into 2 lots.
- The existing dwelling and structures (in-ground pool, shed, and detached garage will remain, and the lot will be reduced to approximately 1.2 acres (48,560 square feet).
- Township bulk zoning requirements will be maintained.
- A new lot will be created with a leg access to the new dwelling.
- A new single-family residence is proposed to be 2,500 to 3,000 square feet.
- The new lot will be approximately 0.8 acres (34,460 square feet).

Zoning Information:

- ❖ The property is in the R-3 Medium Density Residential District.
- ❖ Single-family detached dwellings are a use permitted by right.
- ❖ The minimum lot area is 18,000 square feet.
- ❖ The front yard is 30 feet, the side yard is 20 feet, and the rear yard is 30 feet.
- ❖ The minimum building height is 30 feet (3 stories).
- ❖ Total impervious cover is 35%.
- ❖ Total building cover is 25%.
- ❖ The zoning also, notes that design and landscaping controls in 240-27D shall apply to residential development in this district.

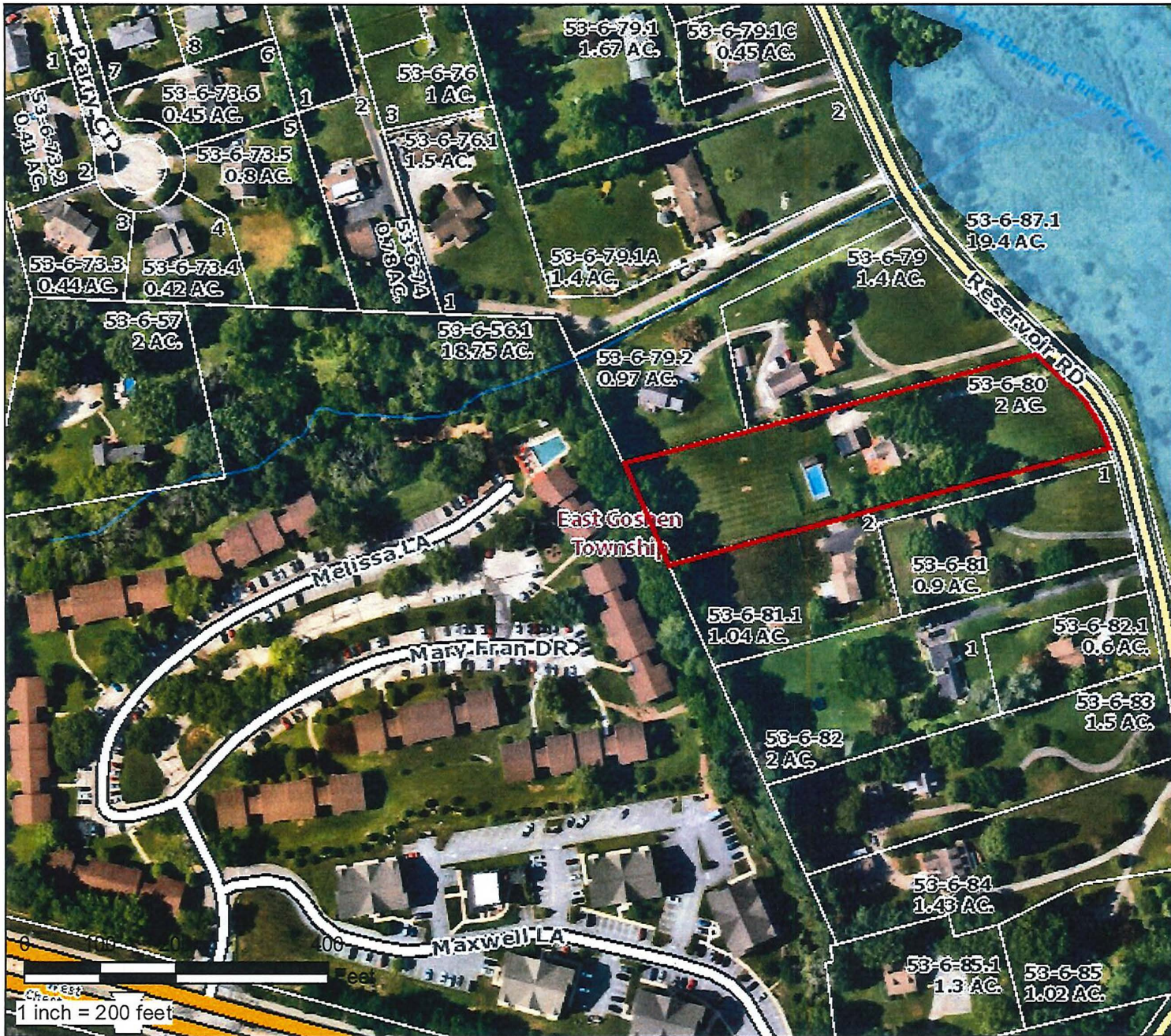

Find Address Information

PARID: 5306 00800000
 UPL: 53-6-80
 Owner1: GLOSSON JEFFREY SCOTT
 Owner2: GLOSSON MICHELLE
 APRIL
 Mail Address 1: 14 RESERVOIR RD
 Mail Address 2: WEST CHESTER PA
 Mail Address 3:
 ZIP Code: 19380
 Deed Book: 9154
 Deed Page: 952
 Deed Recorded Date: 07/31/2015
 Legal Desc 1: WS OF RESERVOIR RD
 Legal Desc 2: 2 ACDWG & DET GAR
 Acres: 2
 LUC: R-10
 Lot Assessment: 97530
 Property Assessment: 95150
 Total Assesment: 192680
 Assessment Date: 12/15/2021 7:48:09 AM
 Property Address: 14 RESERVOIR RD
 Municipality: EAST GOSHEN
 School District: West Chester Area

Map Created:
Wednesday, September 28, 2022

County of Chester



Limitations of Liability and Use:
 County of Chester, Pennsylvania makes no claims to the completeness, accuracy, or content of any data contained herein, and makes no representation of any kind, including, but not limited to, the warranties of merchantability or fitness for a particular use, nor are any such warranties to be implied or inferred with respect to the information or data furnished herein. For information on data sources visit the GIS Services page listed at www.chesco.org/gis.



EAST GOSHEN TOWNSHIP
CHESTER COUNTY, PA

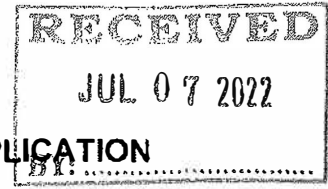

SUBDIVISION AND / OR LAND DEVELOPMENT APPLICATION

Date Filed: _____

Application for (Circle one):

Subdivision Land Development Subdivision & Land Development

A. Application is hereby made by the undersigned for approval of a Subdivision and or Land Development Plan, more particularly described below.

1. Applicant's name: Jeffrey S. & Michelle A. Glosson

Address: 14 Reservoir Road, West Chester, PA 19380 Phone: 484-364-6167

Fax: _____ Email: jsglosson@gmail.com

2. Name and address of present owner (if other than 1. above)

Name: Same as above

Address: _____ Phone: _____

Fax: _____ Email: _____

3. Location of plan: 14 Reservoir Rd., West Chester, PA 19380

4. Proposed name of plan: _____

5. County Tax Parcel No.: 53-6-80 Zoning District: R-3

6. Area of proposed plan (ac.): 2.0005 Number of lots: 2

7. Area of open space (ac.): N/A

8. Type of structures to be constructed: Residential single-family home

9. What provisions are to be made for water supply and sanitary sewer? _____

Connection to public water and sewer

10. Linear feet of road to be constructed: Driveway 359.5'

11. Name of Engineer: Nicholas Cirilli, Yerkes Associates, Inc.

Phone Number: 610-644-4254 Fax: 610-640-0771

Email address: ncirilli@comcast.net

EAST GOSHEN TOWNSHIP, CHESTER COUNTY PA
SUBDIVISION AND/OR LAND DEVELOPMENT APPLICATION

12. Name of Land Planner: Same as above

Phone Number: _____ Fax: _____

Email address: _____

- B. I/We agree to reimburse the Township of East Goshen for such fees and expenses the Township may incur for the services of an Engineer(s) in investigations, tests, and review in relation to the Subdivision Plan.
- C. I/We agree to post financial security for the improvements depicted on the Subdivision and or land Development Plan pursuant to the Subdivision and Land Development Ordinance.
- D. I/We agree to reimburse the Township of East Goshen for all inspection fees at the actual cost to Township.

NOTICE

The Township requires an Occupancy Permit before any building can be occupied; no Occupancy Permit will be issued until final inspection and approved by the Zoning Officer and Building Inspector.

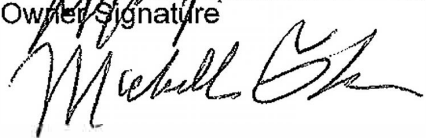

Owner Signature

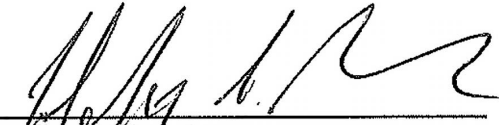

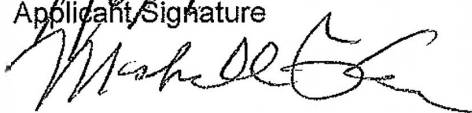
Applicant Signature

Administrative Use

Fees received from applicant \$ _____ basic fee, plus \$ _____ per lot

For _____ lots = \$ _____.

Application and plan received by: _____ Date: _____
(Signature)

Application accepted as complete on: _____
(Date)

EAST GOSHEN TOWNSHIP, CHESTER COUNTY PA
SUBDIVISION AND/OR LAND DEVELOPMENT APPLICATION

SUBDIVISION AND/OR LAND DEVELOPMENT CHECKLIST

This checklist outlines the steps and items needed to insure completeness of the application and to insure the application follows the process and conforms to the timeframe outlined by the State of Pennsylvania and East Goshen Township. This checklist is broken into two parts, the Application Process and the Review Process. The application process must be completed in its entirety prior to the advancement into the Review Process.

* Review the formal Planning Commission review procedure on page five.

Application for (Circle all appropriate): Subdivision Land Development

Applicant Information:

Name of Applicant: Jeffrey S. & Michelle A. Glosson

Address: 14 Reservoir Road, West Chester, PA 19380

Telephone Number: 484-364-6167 Fax: N/A

Email Address: jsglosson@gmail.com

Property Address: 14 Reservoir Road, West Chester, PA 19380

Property Information:

Owner's Name: Jeffrey S. & Michelle A. Glosson

Address: 14 Reservoir Road, West Chester, PA 19380

Tax Parcel Number: 53-6-80 Zoning District: R-3 Acreage: 2.0005

Description of proposed subdivision and or land Development:

Existing single-family residential property, on 2.0005 acres is to be subdivided into 2 lots. The existing home and structures will remain and the lot will be reduced to approximately 1.2 acres (48,560 square feet), while maintaining the township bulk zoning requirements. A new subdivided lot, with access leg, will be utilized for building a new single-family residence proposed to be roughly 2500-3000 square feet. This new proposed lot will be approximately 0.8 acres (34,460 square feet) and will conform to township bulk zoning requirements.

JEFFREY S. GLOSSON
MICHELLE A. GLOSSON
14 RESERVOIR RD.
WEST CHESTER, PA 19380

1594
60-8111/2313

JULY 6, 2022
DATE

PAY TO THE
ORDER OF

EAST GOSHEN TOWNSHIP — \$ 300.00
THREE HUNDRED AND ⁰⁰/₁₀₀ DOLLARS



PSECU

HARRISBURG, PA 17110-2990

FOR SUBDIVISION APP. FEE

[Signature]

⑆ 23 638 6 6 6 6 ⑆ 04543 6664 7 ⑆ 1594

JEFFREY S. GLOSSON
MICHELLE A. GLOSSON
14 RESERVOIR RD.
WEST CHESTER, PA 19380

1595

60-8111/2313

JULY 6, 2022
DATE

PAY TO THE
ORDER OF

EAST GOSHEN TOWNSHIP \$ 2,000.00

TWO THOUSAND AND

00
10000 DOLLARS



Photo
Safe
Deposit™
Disk on back

PSECU[®]

HARRISBURG, PA 17110-2990

FOR SUBORDINATION ESCROW

[Signature]

⑆ 231381116⑆ 0454316647⑈ 1595

Return to: Chester County Planning Commission
 601 Westtown Road-Suite 270
 P.O. Box 2747
 West Chester, PA 19380-0990

SEP 21 2022

Act 247 County Referral

To: Chester County Planning Commission
Subject: Request for review of a subdivision, land development proposal, ordinances, or comprehensive plans pursuant to the Pennsylvania Municipalities Planning Code, Act 247. This application must be completed by the applicant, and submitted by the municipality to the above address, along with one (1) complete set of plans and accompanying documents and the required fee for review (see reverse side)

TO BE COMPLETED BY THE MUNICIPALITY
 From: (Municipality) _____
 Date: _____
 Official's Name: _____
 Position: _____
 Official's signature: _____
 Applications with **ORIGINAL** signatures must be submitted to CCPC.

TO BE COMPLETED BY THE APPLICANT
 Development name (if applicable): N/A Location: N/A
 Owner's name: Jeffrey S. & Michelle A. Glosson Phone #: 484-364-6167
 Owner's address: 14 Reservoir Rd., West Chester, PA 19380
 Applicant's name: Jeffrey S. Glosson Phone #: 484-364-6167
 Applicant's address: 14 Reservoir Rd., West Chester, PA 19380
 Architect/Engineer/Surveyor name: Yerkes Associates, Inc. Phone #: 610-640-0771

TYPE OF REVIEW REQUESTED
 (Check all appropriate boxes)

Unofficial sketch plan (no fee)
 Subdivision plan
 Land development plan
 Planned residential development
 Zoning ordinance (no fee)
 Curative amendment (no fee)
 Subdivision ordinance (no fee)
 Comprehensive plan (no fee)
 Other _____

REVIEW FEE
 (Fee schedule on other side)

Attached \$ 175.00
 Not applicable

TYPE OF PLAN

Unofficial sketch
 Preliminary
 Final

TYPE OF SUBMISSION

New proposal
 Revision to a prior proposal
 Phase of a prior proposal
 Amendment/revision to recorded plan is a new proposal

Tax parcel(s): # 53-6-80
 # _____
 # _____

Total area (gross acres): 2.0005

PLAN INFORMATION

Length of new roads: N/A
 Number of new parking spaces: N/A
 Ownership of roads:
 Public Private
 Open space:
 Public Private
 Acres: _____ Acres: _____
 HOA responsible for common facilities/areas:
 Yes No
 HOA documents provided:
 Yes No
 Traffic study included:
 Yes No Not conducted

LAND USE	# of lots/units
Agriculture	
<input checked="" type="checkbox"/> Single family	2
Townhouses	
Twin units	
Apartments	
Mobile homes	
*Commercial	
*Industrial	
*Institutional	
Other	

ZONING DISTRICT OF PROPOSAL

Existing: R-3
 Proposed: R-3
 Variances/
 Special exception granted: _____

PROPOSED UTILITIES
 (Check appropriate boxes)

	Water	Sewer
Public	<input checked="" type="checkbox"/>	<input checked="" type="checkbox"/>
On-site	<input type="checkbox"/>	<input type="checkbox"/>
Package	<input type="checkbox"/>	<input type="checkbox"/>

No new sewage disposal or water supply proposed

***Information to be filled in for Commercial, Industrial or Institutional land use ONLY**

*Total square footage of addition to existing building: _____
 *Total square footage of new building(s): _____

ADDITIONAL INFORMATION (This plan has been submitted to):

County Health Department Date _____
 PennDOT Date _____
 DEP Date _____
 Other _____ Date _____

THE TERM "LOTS"
 The term "LOTS" includes conveyance, tracts or parcels of land for the purpose, whether immediate or future, of lease, transfer of ownership or building or development, as well as residue parcels, annexations, or the correction of lot lines.

FEE SCHEDULE

The following fees shall apply to each land subdivision or land development submitted to the Chester County Planning Commission for review in accordance with Article V, Section 502, Pennsylvania Municipalities Planning Code, Act 247, as amended.

- If a plan for a non-residential use is to be subdivided and developed, the fee is the total of Category II plus Category III.
- For Categories I and II, the fee applies to total number lots/units after subdivision. Subdivisions include lot line revisions and lot consolidations.
- Maximum one-time fee: \$10,000.

CATEGORY I RESIDENTIAL SUBDIVISION OR LAND DEVELOPMENT

These fees apply to residential projects for sale, condominium ownership, or rental; any type of buildings, either as a subdivision or single tract land development; or an agricultural subdivision (except for guidelines in Article I, Section 107, Subdivision, Pennsylvania Municipal Planning Code, Act 247, as amended). This category does not include institutional living facilities.

Number of lots and dwelling units	Base fees	Fees for each lot and/or unit
1-2 lots/dwelling units	\$175.00	None
3-5 lots/dwelling units	\$175.00	Plus \$29.00/lot/unit
6-20 lots/dwelling units	\$235.00	Plus \$26.00/lot/unit
21-75 lots/dwelling units	\$425.00	Plus \$23.00/lot/unit
76 lots/dwelling units and over	\$850.00	Plus \$18.00/lot/unit

CATEGORY II NON-RESIDENTIAL SUBDIVISIONS

These fees apply to applications for subdivision and conveyance of land for non-residential uses, not proposed for land development as defined in Section 107 of the Planning Code.

Number of lots or units	Base fees	Fees for each lot and/or unit
1-2 lots/units	\$295.00	Plus \$57.00/lot/unit
3-10 lots/units	\$585.00	Plus \$57.00/lot/unit
11 lots/units and over	\$850.00	Plus \$53.00/lot/unit
Financial subdivisions	\$295.00	Plus \$57.00/lot/unit

CATEGORY III NON-RESIDENTIAL LAND DEVELOPMENT

These fees apply to all projects or sections of mixed projects which are for non-residential use for sale, condominium, lease or rent in any type of building on a single tract of land.

Building square footage (gross)	Base fees	Fees for gross floor area
0 to 5,000 sq. ft.	\$480.00	Plus \$47.00/1,000 sq. ft. of gross floor area
5,001 to 25,000 sq. ft.	\$585.00	Plus \$42.00/1,000 sq. ft. of gross floor area
25,001 to 75,000 sq. ft.	\$955.00	Plus \$42.00/1,000 sq. ft. of gross floor area
75,001 sq. ft. and over	\$1,435.00	Plus \$29.00/1,000 sq. ft. of gross floor area

CATEGORY IV SECOND REVIEWS

These fees apply to each review conducted after the first review (within a three (3) year period of the initial review) and only if requested by the municipality.

- Flat fee of \$175.00 for residential subdivisions/land developments
- Flat fee of \$235.00 for non-residential subdivisions/land developments

CHECKS OR MONEY ORDERS SHOULD BE PAYABLE TO: County of Chester

Cash will not be accepted. All fees are to be submitted to the Chester County Planning Commission (CCPC) through the appropriate township or borough at the time of application; and in accordance with the administrative guidelines established by CCPC. Upon written request from the municipality, CCPC may waive the fees for plan reviews associated with municipally-owned subdivisions or land developments.

INFORMAL REVIEWS AND ADDITIONAL WORK:

An informal review request to CCPC (such as meetings and discussions prior to the formal development application) shall be free of charge if said written request is from the municipality, or from an applicant with the knowledge and written consent of the municipality. In no case will informal review by CCPC replace the need for a formal review which would include the submission of the required fee listed above pursuant to the Municipalities Planning Code.

TIME LIMITATIONS:

The review time period will begin from the date of receipt by CCPC of the application requesting a review by CCPC. CCPC has thirty (30) days within which to review subdivision and land development applications and submit review comments. The review period may be extended if requested by the applicant or a time extension has been granted by the municipality with the concurrence of the applicant. When the time period has been stopped due to an incomplete application package, incorrect fee submittal or other reasons, the time period will continue from the day in which the application package is complete. CCPC has thirty (30) days within which to review ordinance amendments, and forty-five (45) days within which to review comprehensive plans, official maps, and complete ordinances.

NOTE: ALL LOCATIONS OF EXISTING UTILITIES SHOWN ON THIS PLAN HAVE BEEN DEVELOPED FROM EXISTING UTILITY RECORDS AND/OR ABOVE GROUND EXAMINATION OF THE SITE. COMPLETENESS OR ACCURACY OF LOCATION AND DEPTH OF UNDERGROUND UTILITIES OR STRUCTURES CANNOT BE GUARANTEED. CONTRACTOR MUST VERIFY LOCATION AND DEPTH OF ALL UNDERGROUND UTILITIES AND FACILITIES BEFORE START OF WORK PER PENNSYLVANIA ACT 287 OF 1974 AS AMENDED BY ACT 199 OF 2004. SERIAL #



NOTES:

1. THIS IS THE SAME PREMISES DESCRIBED IN RECORD BOOK 9154 PAGE 952 RECORDED AT THE CHESTER COUNTY RECORDER OF DEEDS.
2. THIS PLAN IS BASED UPON A FIELD SURVEY IMPROVEMENTS SHOWN FROM A FIELD SURVEY BY YERKES ASSOCIATES, INC., IN APRIL 2017 UNDERGROUND UTILITIES ARE SHOWN BASED UPON A PA ONE CALL IN 2021.
3. THIS PLAN HAS BEEN PREPARED WITHOUT THE AD OF A TITLE REPORT.
4. ELEVATION DATUM IS APPROXIMATE CHESTER COUNTY GIS.
5. TREE NAMES AND CALIPER ARE APPROXIMATE.
6. UNDERGROUND UTILITIES HAVE BEEN SHOWN BASED UPON A PA ONE BUT OTHER UTILITIES MAY EXIST THAT HAVE NOT BEEN LOCATED NOR SHOWN.
7. THE INTENT OF THIS PLAN IS TO SUBDIVIDE THE PROPERTY CREATING A NEW VACANT LOT, LOT 2.
8. A VARIANCE WAS GRANTED ON JULY 21, 2021 FOR A 24' POLE PORTION OF THE FLAG LOT, LOT 2.
9. THE TRACT ERROR OF CLOSURE IS 1 : 433,647

BULK ZONING:

DISTRICT	R-3 MEDIUM DENSITY RESIDENTIAL
MIN. LOT AREA	18,000 SQUARE FEET
MIN. LOT WIDTH	100 FEET @ BUILDING SETBACK
MIN. FRONT YARD	50 FEET @ STREET
MIN. SIDE YARD	30 FEET
MIN. REAR YARD	30 FEET
MAX. BUILDING COVERAGE	25 PERCENT
MAX. LOT COVERAGE	35 PERCENT
MAX. BUILDING HEIGHT	30 FEET OR 3 STORIES

LOT AREAS: SQUARE FEET

TOTAL TRACT AREA	87143
LOT 1 TOTAL	50514
LOT 1 RW	2620
LOT 1 NET	47894
LOT 2 TOTAL	36629
LOT 2 RW	287
LOT 2 NET	36332

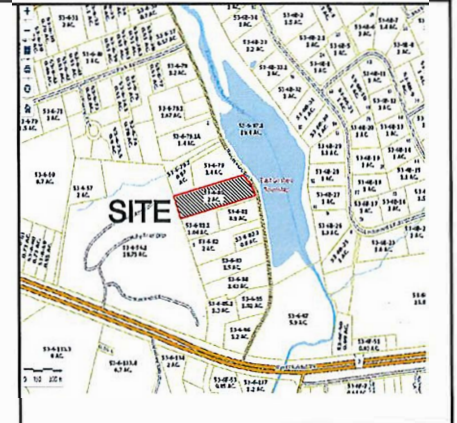

LOCATION MAP



STATE OF _____
 COUNTY OF _____
 ON THIS, THE ____ DAY OF _____, 202____,
 BEFORE ME _____ THE
 UNDERSIGNED OFFICER, PERSONALLY APPEARED _____
 KNOWN TO ME TO BE THE PERSON WHOSE NAME IS
 SUBSCRIBED TO THE WITHIN INSTRUMENT, AND
 ACKNOWLEDGED THAT THEY EXECUTED THE SAME
 FOR THE PURPOSES THEREIN CONTAINED.

REVIEWED BY THE EAST GOSHEN PLANNING COMMISSION
 DATE _____

APPROVED BY THE EAST GOSHEN BOARD OF SUPERVISORS
 DATE _____

REVIEWED BY THE EAST GOSHEN TOWNSHIP ENGINEER
 DATE _____

REVIEW BY THE CHESTER COUNTY PLANNING COMMISSION
 DATE _____

TOTAL LOT AREA = 2.0005 ACRES
 NET LOT AREA = 1.9345 ACRES

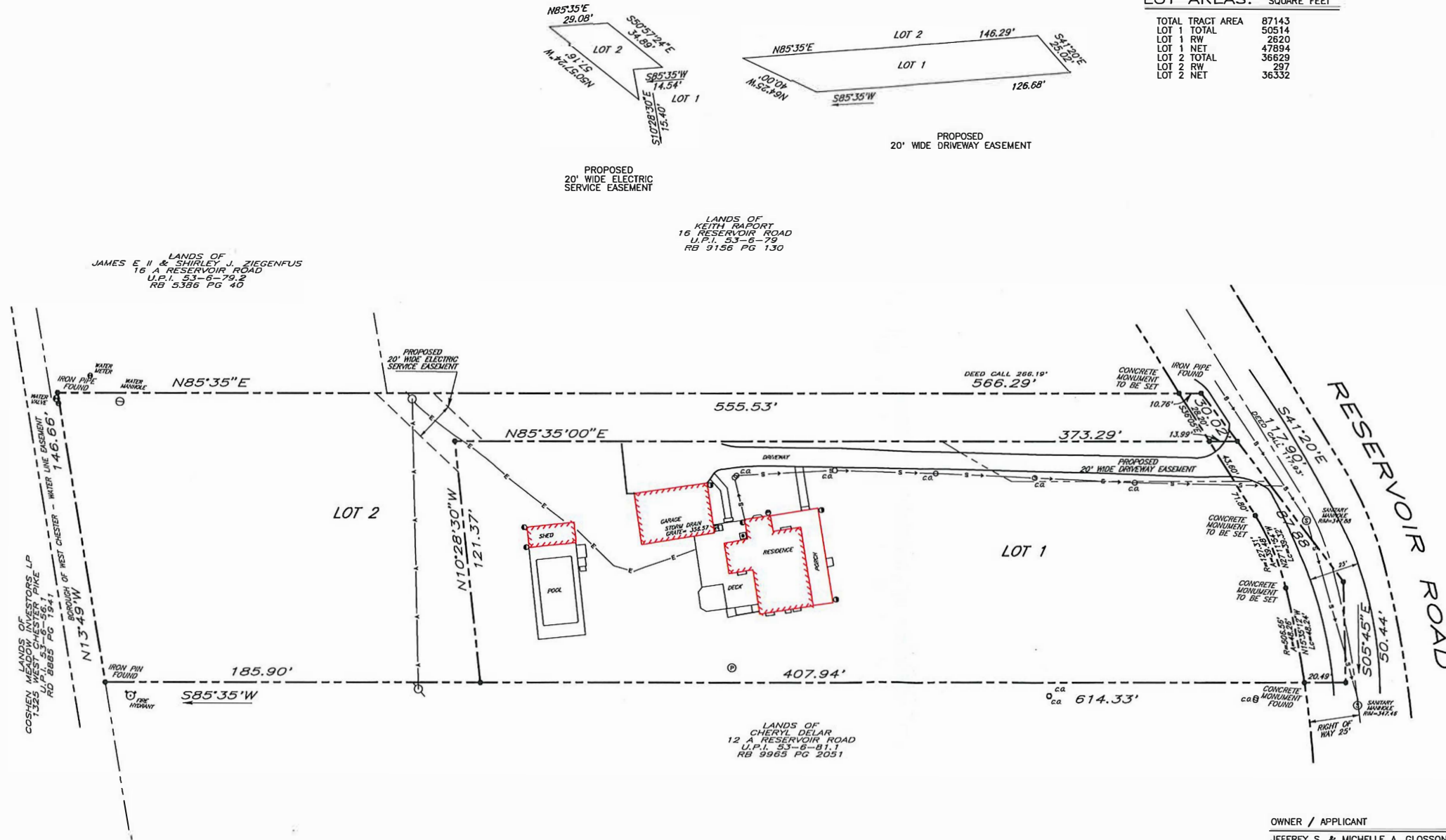

LANDS OF JAMES E II & SHIRLEY J. ZIEGENFUS
 16 A RESERVOIR ROAD
 U.P.L. 53-6-79
 RB 5386 PG 40

LANDS OF KEITH RAPORT
 16 RESERVOIR ROAD
 U.P.L. 53-6-79
 RB 9156 PG 130

LANDS OF CHERYL DELAR
 12 A RESERVOIR ROAD
 U.P.L. 53-6-91.1
 RB 9965 PG 2051

LANDS OF COSLEY MESSON INVESTORS, LP
 1356 WEST CHESTER PIKE
 U.P.L. 53-6-156.1
 RD 8865 PG 184.1

OWNER / APPLICANT

JEFFREY S. & MICHELLE A. GLOSSON
 14 RESERVOIR ROAD
 WEST CHESTER, PA 19380

LAND SURVEYOR

NICHOLAS CIRILLI
 YERKES ASSOCIATES, INC.
 1444 PHOENIXVILLE PIKE
 WEST CHESTER, PA 19380
 610-644-4254

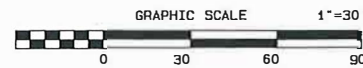

9/14/2022 1:41:16 W:\W-16-2100 - GLOSSON\W2100 SUBDIVISION R1.dwg

BY AFFIXING MY SEAL TO THIS PLAN I CERTIFY THIS PLAN IS ACCURATE AND IS IN CONFORMANCE WITH THE TOWNSHIP ORDINANCE TO THE BEST OF MY KNOWLEDGE.

1	SEPTEMBER 14, 2022	NOT THIS SHEET
NO.	DATE	REVISION COMMENT
TITLE PLAN		
14 RESERVOIR ROAD - SUBDIVISION PREPARED FOR JEFFREY S. & MICHELLE A. GLOSSON EAST GOSHEN TOWNSHIP • CHESTER COUNTY • PENNSYLVANIA		
PROJECT	W-16-2100	
DATE	JUNE 1, 2022	
SCALE	1" = 30'	
DRAWN	SWB	
CHECKED	JAG/HC	
CAD FILE	W2100 SUBDIVISION	
TAX PARCEL	53-6-80	
PLAN NO.	C-53-6-80	
Yerkes ASSOCIATES, INC. <i>a crill company</i>		
CONSULTING ENGINEERS / STRUCTURAL ENGINEERING SITE PLANNERS / LAND SURVEYORS / MUNICIPAL SERVICES		
1444 PHOENIXVILLE PIKE • P.O. BOX 1568 • WEST CHESTER, PA 19380 TEL: (610) 644-4254 • FAX: (610) 640-0771		
SHEET 1 OF 6		

NOTE: ALL LOCATIONS OF EXISTING UTILITIES SHOWN ON THIS PLAN HAVE BEEN DEVELOPED FROM EXISTING UTILITY RECORDS AND/OR ABOVE GROUND EXAMINATION OF THE SITE. COMPLETENESS OF ACCURACY OF LOCATION AND DEPTH OF UNDERGROUND UTILITIES OR STRUCTURES CANNOT BE GUARANTEED. CONTRACTOR MUST VERIFY LOCATION AND DEPTH OF ALL UNDERGROUND UTILITIES AND FACILITIES BEFORE START OF WORK PER PENNSYLVANIA ACT 287 OF 1974 AS AMENDED BY ACT 199 OF 2004. SERIAL #

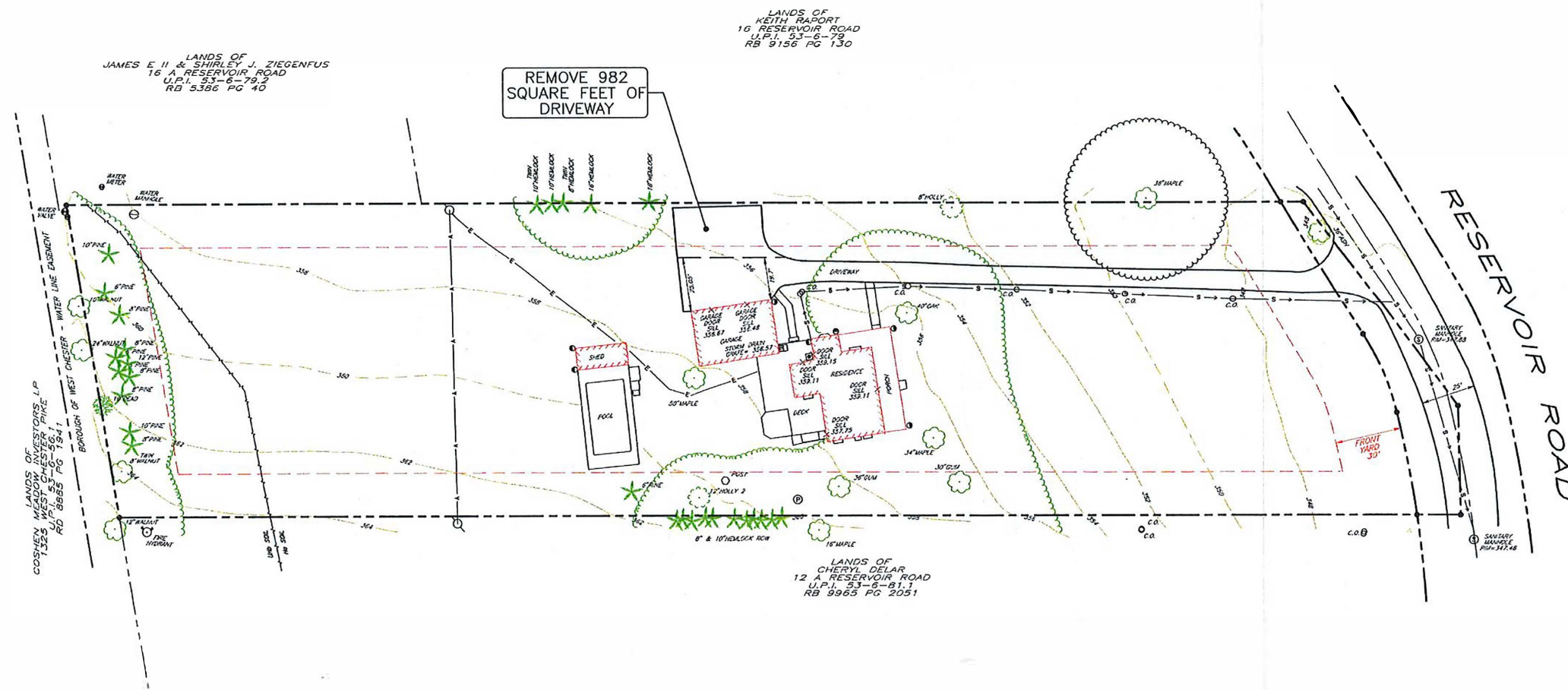
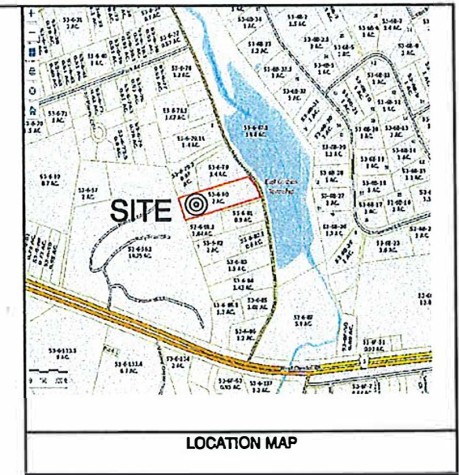

BULK ZONING:

DISTRICT	R-3 MEDIUM DENSITY RESIDENTIAL
MIN. LOT AREA	18,000 SQUARE FEET
MIN. LOT WIDTH	100 FEET @ BUILDING SETBACK
	50 FEET @ STREET
MIN. FRONT YARD	30 FEET
MIN. SIDE YARD	20 FEET
MIN. REAR YARD	30 FEET
MAX. BUILDING COVERAGE	25 PERCENT
MAX. LOT COVERAGE	35 PERCENT
MAX. BUILDING HEIGHT	30 FEET OR 3 STORIES

IMPERVIOUS COVERAGE: SQUARE FEET

RESIDENCE	1934
GARAGE	942
SHED	241
SUB TOTAL	3117 / 84226 = 3.70 PERCENT
STAIRWELL	67
POOL, DECK AND STEPS	1127
DRIVEWAY	4286
DECK	900
FRONT STEP	14
EAST WALK	88
WEST WALK	88
TOTAL	9687 / 84226 = 11.50 PERCENT

NOTES:

1. THIS IS THE SAME PREMISES DESCRIBED IN RECORD BOOK 9154 PAGE 952 RECORDED AT THE CHESTER COUNTY RECORDER OF DEEDS.
2. THIS PLAN IS BASED UPON FIELD SURVEYS BY YERKES ASSOCIATES, INC.
3. ELEVATION DATUM IS APPROXIMATE CHESTER COUNTY GIS.
4. THE SITE BENCHMARK IS THE RIM OF THE SANITARY MANHOLE.
5. THIS PLAN HAS BEEN PREPARED WITHOUT THE AID OF A TITLE REPORT.
6. UNDERGROUND UTILITIES HAVE BEEN SHOWN BASED UPON A PA ONE BUT OTHER UTILITIES MAY EXIST THAT HAVE NOT BEEN LOCATED NOR SHOWN.
7. TREE NAME AND CALIPER ARE APPROXIMATE.

TOTAL LOT AREA = 2.0005 ACRES
NET LOT AREA = 1.9345 ACRES

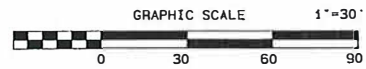

LEGEND:

- DOWNSPOUT
- ⊠ ELECTRIC METER
- ⊠ STORM DRAIN
- AERIAL WIRES
- BURIED WIRES
- SANITARY LATERAL

1	SEPTEMBER 14, 2022	PER TWP PLAN REQUEST
NO.	DATE	REVISION COMMENT
EXISTING CONDITIONS, LANDSCAPE AND DEMOLITION PLAN		
14 RESERVOIR ROAD - SUBDIVISION PREPARED FOR JEFFREY S. & MICHELLE A. GLOSSON EAST GOSHEN TOWNSHIP • CHESTER COUNTY • PENNSYLVANIA		
Yerkes ASSOCIATES, INC. <i>a civil company</i>		
CONSULTING ENGINEERS / STRUCTURAL ENGINEERING SITE PLANNERS / LAND SURVEYORS / MUNICIPAL SERVICES		
1444 PHOENIXVILLE PIKE • P.O. BOX 1568 • WEST CHESTER, PA 19380 TEL: (610) 644-4254 • FAX: (610) 640-0771		
PROJECT - W-16-2100		 PROJECT ARCHITECT J. Grande PROJECT ENGINEER J. Grande
DATE - JUNE 1, 2022		
SCALE - 1" = 30'		
DRAWN - MWD		
CHECKED - JAG/KC		
CAD FILE - W2100 SUBDIVISION		
TAX PARCEL - 53-6-80		
PLAN NO. C-53-6-80		
SHEET 2 OF 6		

BY AFFIXING MY SEAL TO THIS PLAN I CERTIFY THIS PLAN IS ACCURATE AND IS IN CONFORMANCE WITH THE TOWNSHIP ORDINANCE TO THE BEST OF MY KNOWLEDGE.

9/20/2022 : W:\W-16-2100 - 2085\W-16-2100 - GLOSSON\W2100 SUBDIVISION R1.dwg

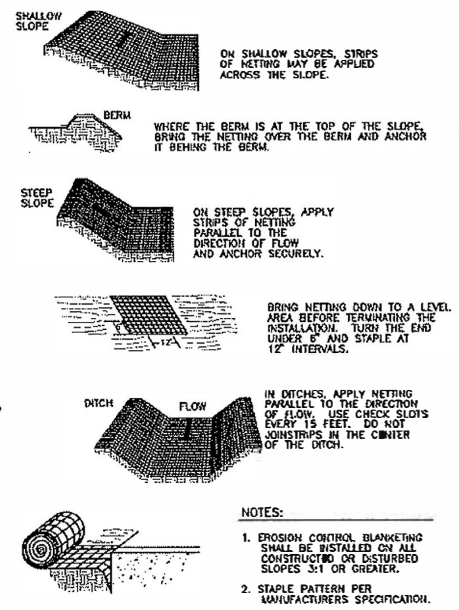
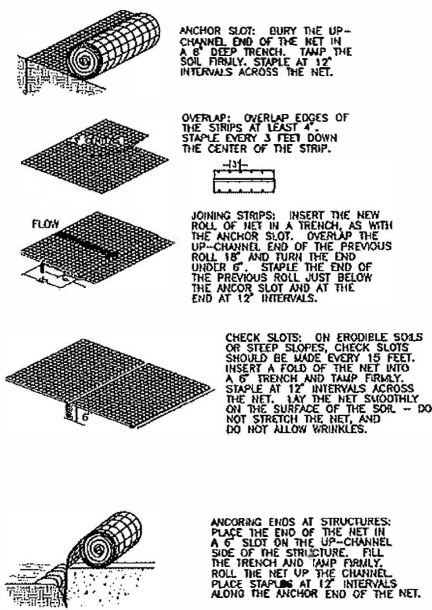

EROSION CONTROL BLANKETING
NOT TO SCALE

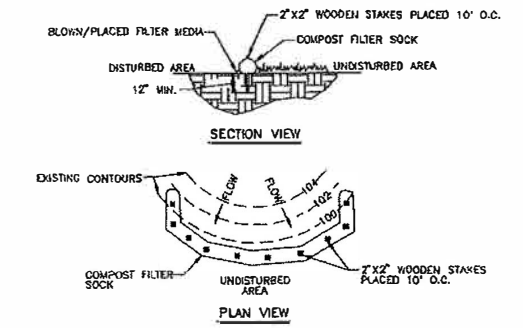

COMPOST SHALL MEET THE FOLLOWING STANDARDS

ORGANIC MATTER CONTENT	80% - 100% (DRY WEIGHT BASIS)
ORGANIC PORTION	FIBROUS AND ELONGATED
pH	5.5-8.0
MOISTURE CONTENT	35%-55%
PARTICLE SIZE	98% PASS THROUGH 1" SCREEN
SOLUBLE SALT CONCENTRATION	5.0 gS/m MAXIMUM

COMPOST FILTER SOCK SHALL BE INSTALLED AT EXISTING LEVEL GRADE WITH LASER LEVEL. BOTH ENDS OF THE SOCK SHALL BE EXTENDED AT LEAST 8 FEET UP SLOPE AT 45 DEGREES TO THE HORN SOCK ALONGSIDE (SEE FIGURE 4.1 OF THE PA DEP E&S MANUAL). MAXIMUM SLOPE LENGTH ABOVE ANY SOCK SHALL NOT EXCEED THAT SHOWN ON FIGURE 4.2 (OF THE PA DEP E&S MANUAL).

TRAFFIC SHALL NOT BE PERMITTED TO CROSS FILTER SOCKS.

ACCUMULATED SEDIMENT SHALL BE REMOVED WHEN IT REACHES 1/2 THE ABOVE GROUND HEIGHT OF THE SOCK AND DISPOSED IN THE MANNER DESCRIBED ELSEWHERE IN THE PLAN.

SOCKS SHALL BE INSPECTED WEEKLY AND AFTER EACH RUNOFF EVENT. DAMAGED SOCKS SHALL BE REPAIRED ACCORDING TO MANUFACTURER'S SPECIFICATIONS OR REPLACED WITHIN 24 HOURS OF INSPECTION.

BIODEGRADABLE FILTER SOCK SHALL BE REPLACED AFTER 6 MONTHS. PHOTODEGRADABLE SOCKS AFTER 1 YEAR. POLYPROPYLENE SOCKS SHALL BE REPLACED ACCORDING TO MANUFACTURER'S RECOMMENDATIONS.

UPON STABILIZATION OF THE AREA TRIBUTARY TO THE SOCK, STAKES SHALL BE REMOVED. THE SOCK MAY BE LEFT IN PLACE AND VEGETATED OR REMOVED. IN THE LATTER CASE, THE MESH SHALL BE CUT OPEN AND THE MULCH SPREAD AS A SOIL SUPPLEMENT.

COMPOST FILTER SOCK
NOT TO SCALE

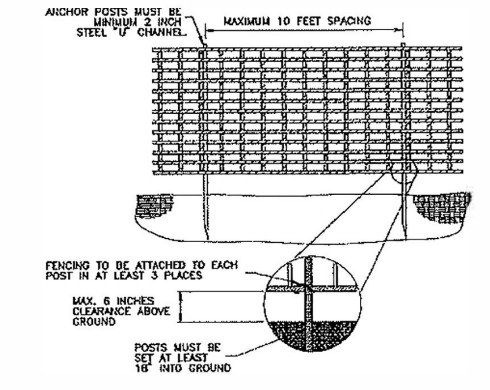

- PROTECTION BARRIER SHALL BE 4 FEET HIGH, CONSTRUCTED OF DURABLE AND HIGHLY VISIBLE MATERIAL (PLASTIC ORANGE CONSTRUCTION FENCE OR SNOW FENCE MAY BE USED).
- PROTECTION BARRIERS SHALL BE MAINTAINED THROUGHOUT THE DURATION OF THE WORK AT THE SITE.

TREE PROTECTION FENCE
NOT TO SCALE

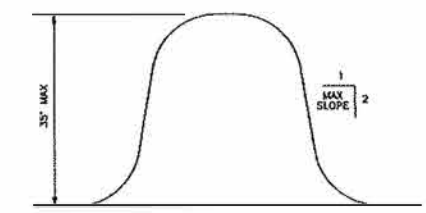

TOPSOIL STOCKPILE DETAIL
NOT TO SCALE

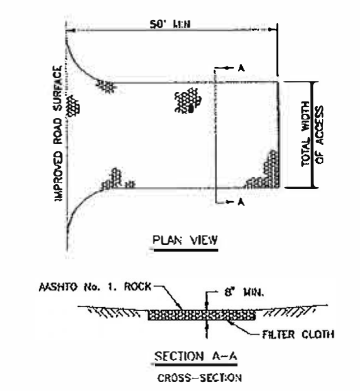

- ROCK CONSTRUCTION ENTRANCE ONLY TO BE INSTALLED IF HANDWASHING TRAYS OF ALL EQUIPMENT DOES NOT PREVENT SEDIMENT FROM LEAVING THE CONSTRUCTION SITE AS DETERMINED BY TOWNSHIP ENGINEER. THE LOCATION SHALL BE PER PLAN OR AS DIRECTED BY TOWNSHIP ENGINEER.

ROCK CONSTRUCTION ENTRANCE
NOT TO SCALE

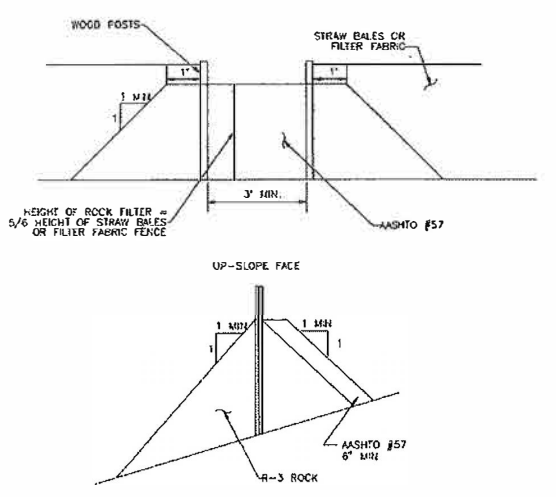

- NOTES:
- TO BE USED WHERE SILT FENCE HAS BEEN UNDERMINED OR TOPPED.
 - SEDIMENT MUST BE REMOVED WHEN ACCUMULATIONS REACH 1/3 THE HEIGHT OF THE OUTLET.

ROCK FILTER OUTLET
NOT TO SCALE

- * STAKES SPACED @ 8' MAXIMUM. USE 2" X 2" WOOD OR EQUIVALENT STEEL STAKES.
- FILTER FABRIC FENCE MUST BE PLACED AT LEVEL EXISTING GRADE. BOTH ENDS OF THE BARRIER MUST BE EXTENDED AT LEAST 8 FEET UP SLOPE AT 45 DEGREES TO THE HORN BARRIER JOINTMENT.
- SEDIMENT MUST BE REMOVED WHEN ACCUMULATIONS REACH 1/2 THE ABOVE GROUND HEIGHT OF THE FENCE.

SILT FENCE
NOT TO SCALE

1. SEPTEMBER 14, 2022		NOT THIS SHEET	
NO.	DATE	REVISION COMMENT	
E&S DETAILS			
14 RESERVOIR ROAD - SUBDIVISION PREPARED FOR JEFFREY S. & MICHELLE A. GLOSSON EAST GOSHEN TOWNSHIP • CHESTER COUNTY • PENNSYLVANIA			
Yerkes ASSOCIATES, INC. <i>a crill company</i>			
CONSULTING ENGINEERS / STRUCTURAL ENGINEERING SITE PLANNERS / LAND SURVEYORS / MUNICIPAL SERVICES			
1444 PHOENIXVILLE PIKE • P.O. BOX 1568 • WEST CHESTER, PA 19380 TEL: (610) 644-4254 • FAX: (610) 640-0771			
PROJECT - W-16-2100		DATE - JUNE 1, 2022	
SCALE -		DRAWN - MNB	
CHECKED - JAO		CAD FILE - W2100 SUBDIVISION	
TAX PARCEL - 53-6-80		PLAN NO. -	
		C-53-6-80	
		SHEET 5 OF 8	

9/20/2022 : W:\W-16-2100 - GLOSSON\W2100 SUBDIVISION R1.dwg

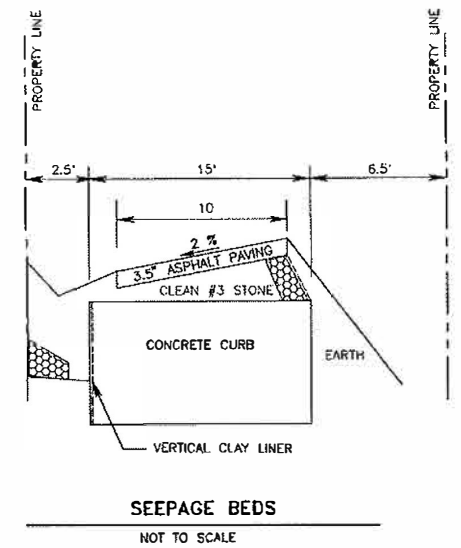
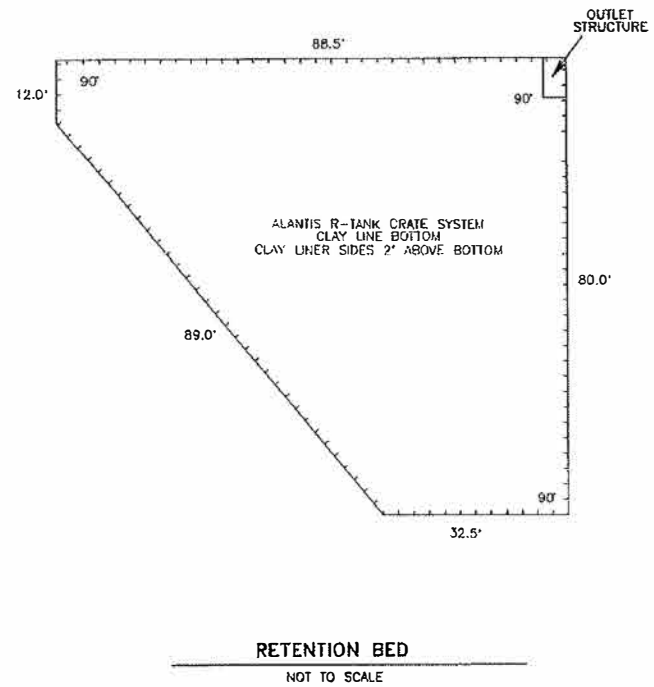
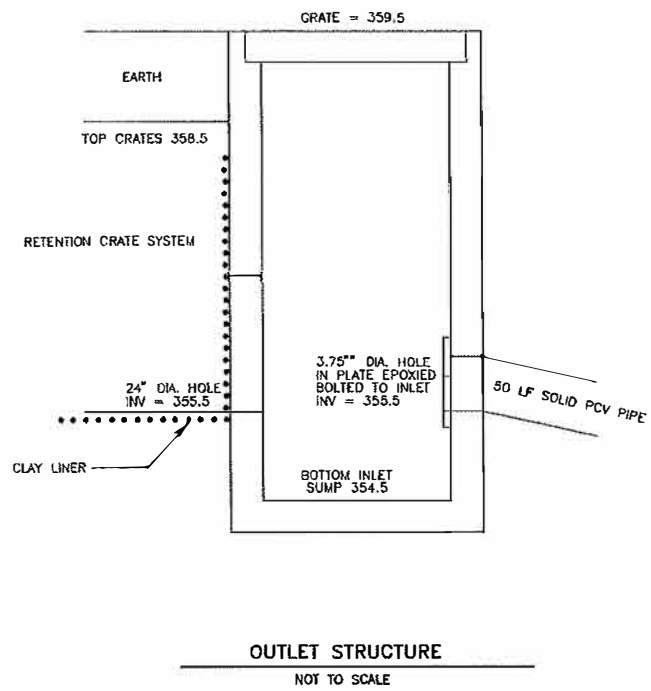

Environmental Management & Consulting, Inc.

INFILTRATION TEST REPORT FOR ON-LOT DISPOSAL OF STORMWATER

Applicant/Client: Yeska Date of Test: 3/6/2022
Site Address/Location: 14 Reservoir Road Municipality: East Goshen Twp.
Person Conducting Test: Mark A. Bryan County: Chester
Weather Conditions: Sunny 32% Dry last 24 Hours Location: SW1/SW2

Test Method: Double-Ring Infiltrometer

Profile Description:
Station Depth (ft.) Description
A 0-11 Dark brown silt loam, moderate granular, very friable, clear boundary
B 11-36 Brown silt loam, strong subangular blocky, friable, gradual
C 36-64 Gray/brown heavy silt loam, strong subangular blocky, sticky/firm

SHWT Molding Limiting Zone encountered to @36"
SHWT Molding Limiting Zone encountered to @29"

Test No.	Test Depth (ft.)	Blot Depth (in.)	PS1	PS2	1	2	3	4	5	6
SW1A	12	12	1.34	1.92	1.14	1.18	1	1		
Time:			:30	:30	:30	:30	:30	:30		
SW1B	12	12	1	3/4	5/8	1/2	1/2	1/2		
Time:			:30	:30	:30	:30	:30	:30		

Calculation of Infiltration Rate:

Test No.	Drop in Fluid Ppt.	Infiltration Interval (Minutes)	Inches	Inches/Hour
SW1A	1	30	30.00	1.00
SW1B	12	30	30.00	1.00

Avg. Infiltration: SW1 1.50

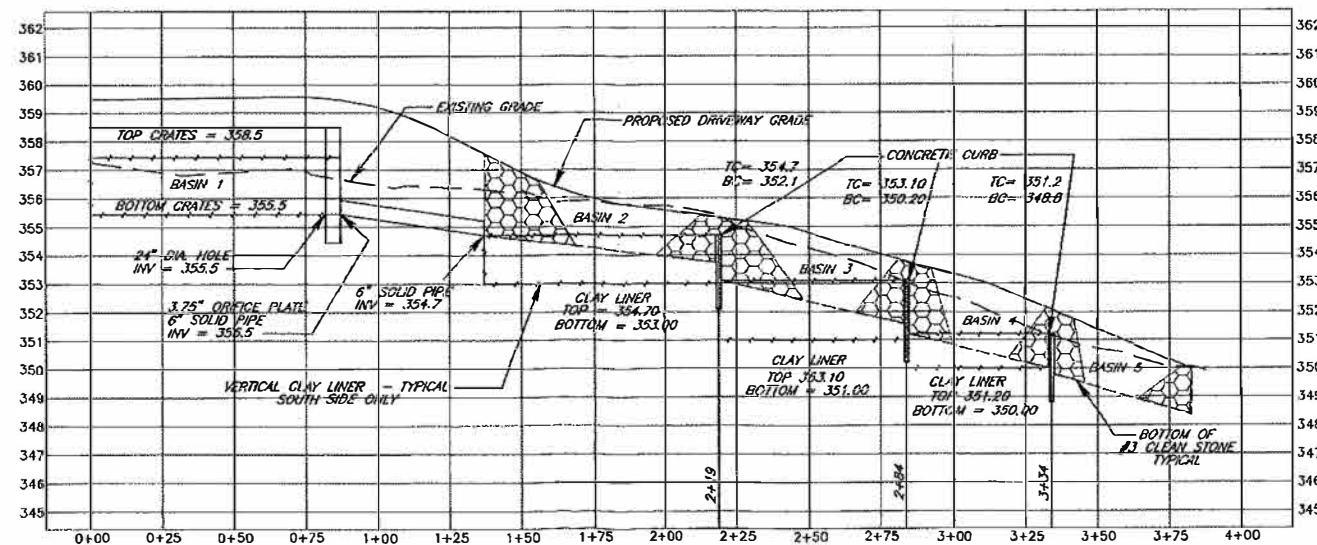

NO.	DATE	REVISION COMMENT
1	SEPTEMBER 14, 2022	PER TWP PLAN REQUEST
CONSTRUCTION DETAIL AND STORMWATER MANAGEMENT PLAN		
14 RESERVOIR ROAD - SUBDIVISION PREPARED FOR JEFFREY S. & MICHELLE A. GLOSSON		
EAST GOSHEN TOWNSHIP • CHESTER COUNTY • PENNSYLVANIA		
Yerkes ASSOCIATES, INC. <small>a crill company</small>		 PROJECT: W-16-2100 DATE: JUNE 1, 2022 SCALE: - DRAWN: MNB CHECKED: JAG CAD FILE: W2100 SUBDIVISION TAX PARCEL: 53-8-80 PLAN NO.: C-53-6-80 SHEET 6 OF 6
CONSULTING ENGINEERS / STRUCTURAL ENGINEERING SITE PLANNERS / LAND SURVEYORS / MUNICIPAL SERVICES		
1444 PHOENIXVILLE PIKE • P.O. BOX 156B • WEST CHESTER, PA 19380 TEL: (610) 644-4254 • FAX: (610) 640-0771		

9/20/2022 : W:\W-15 - 2089\W-15-2-100 - GLOSSON\W2100 SUBDIVISION R1.dwg

September 21, 2022

EGOST00134

Duane Brady, Zoning Officer
East Goshen Township
1580 Paoli Pike
West Chester, PA 19380

**RE: 1010 Hershey Mill Road
Conditional Use/Sketch Plan**

Dear Duane:

As requested, we have reviewed the following information, prepared by dH Enterprises, Inc., regarding the referenced submission:

- "Open Space Development Layout Plan" (one sheet) dated August 22, 2022; and
- Conditional Use application and transmittal letter.

The applicant and equitable owner, Grove Meadow Developers LLC of Berwyn, on behalf of the owners, Mark & Christine Miller of Wayne, request conditional use approval to subdivide and develop UPI 53-1-19 (±16.1 acres) with fifteen (15) single-family residential lots developed under the *Single-Family Open Space Development Option* (§240-36). Two (2) of the lots contain existing buildings and/or historic resources. The parcel is located on the west side of Hershey Mill Road (T-452) approximately 1,950 feet north of its intersection with Greenhill Road, within the R-2 Low Density Residential District and proposed to be required conditional use approval. The development is proposed to be served by public water supply and public sanitary sewer.

We offer the following comments:

1. It is unclear if area and bulk regulations within the underlying R-2 District not specifically addressed or amended within the *Single-Family Open Space Development Option* are applicable. Further discussions with the Zoning Officer and Township Solicitor may be required.
2. Each single-family detached dwelling shall be separated from any other single-family detached dwelling by a minimum of 30 feet. (§240-36.C(1)) There are multiple locations where this requirement is not met.
3. There shall be a minimum of three off-street parking spaces for each unit. Each parking space shall be designed so that the motor vehicle may proceed to and from the parking space provided for it without requiring any other vehicle to be moved. (§240-36.C(6))
4. Rolled curb is required for the proposed cartway width of 18-feet. (240-36.C(4))

5. Please note storage sheds are not a permitted accessory use. (§240-36.D(2)(a))
6. Regarding open space:
 - a. The land development plans shall contain the following statement: "*Open space land may not be separately sold, nor shall such land be further developed or subdivided.*" The subdivision or land development plans shall further designate the use of open space, the type of maintenance to be provided and a planting plan or schedule (§240-36.E).
 - b. All required common open spaces shall be protected by a conservation easement. Ownership for the open space area shall be by any of the following procedures: ownership by Township, a nature organization, individuals, or other (§240-36.E(2)). It is anticipated that the Township prefers a HOA manage the open space, but this should be discussed further with the Board and appropriate management plans, agreements and/or easements established.
 - c. The developer shall provide designated planting and areas suitable for active or passive recreation within open space areas. The use of species of vegetation that are native to the area is encouraged. (§240-36.E(3))
 - d. If the Board determines that an area is needed for active recreation, then a suitable area shall be provided. (§240-36.E(5)(b))
 - e. Open space plans areas shall be designated per §240-36.E(1) as lawn, natural area, recreation area or planting area.
 - f. Common open space areas that are not already wooded and are not approved as lawn, natural areas or recreation areas shall be attractively and extensively landscaped, according to a plan approved by the Board. (§240-36.E(5)(g)) Consideration to buffering adjacent properties should be considered.
 - g. The Township Planning Commission, the Conservancy Board, the Park and Recreation Board and the Historical Commission shall be given the opportunity to inspect the property with the applicant and the design team, in order to determine which areas of the property or which views should be preserved. (§240-36.F(2)) We recommend a site visit be offered to these parties and Township staff and Officials prior to preliminary plan submission.
7. Per discussions with Township Solicitor, it is the Township's opinion that the applicant is proceeding in accordance with §240-36.E(6).
8. Regarding flag lots:
 - a. Per §240-23.B(2)(b)[2][c], a maximum of one (1) one flag lot may be created from each parent lot that existed as a single and separate lot of record at the time of adoption. Two (2) flag lots are proposed.
 - b. The 'pole' portion of the flag lot shall maintain a minimum lot width of forty (40) feet for its full length. (§240-23.B(2)(b)[2][e]) Thirty (30) feet is proposed.
9. We recommend reviewing the environmental protection requirements of §240-25 and flood prone area regulations of §240-26 prior to preliminary submission.
10. Note the process and procedures for conditional use approvals per §240-31.

11. A historic resource impact study (HRIS), prepared by a registered architect specializing in historic preservation and adaptive reuse of historic buildings and structures, shall be submitted to the Township as part of the preliminary plan submission per §240-38.10.A(1).
12. Residential conversion of any structure designated as an historic resource into one or more dwelling units is permitted as a conditional use, subject to the requirements of §240-38.5.A(2)(c). (§240-38.5.A(2)) The Township and/or Historic Commission should confirm the extent of existing historic resources on site, notably Lot 14, which appears to propose re-use of an existing barn. Additional conditional use approval for this may be required.
13. All area and bulk regulations and design standards otherwise applicable in the underlying zoning district shall apply to the use or reuse of an historic resource. However, in order to facilitate the use of the historic resource permitted §240-38.5, the Board of Supervisors, as part of the conditional use approval, may grant modifications to the otherwise applicable area and bulk regulations applicable to the use or adaptive reuse of the historic resource. In no event shall the Board of Supervisors grant modifications to the height requirement and design standards applicable to the historic resource. The applicant should clarify if any modifications are requested.
14. The applicant should contact Mike Ellis, PE (mellis@pennoni.com) and Mark Miller to discuss sanitary sewer requirements; upgrades to the conveyance and/or pump station may be necessary.
15. Stormwater conveyance through the site from the adjacent stormwater management basin to the west shall be accommodated, including any necessary stormwater easements.
16. It may be appropriate to consider pedestrian connections to the neighborhoods to the west and east such as a trail and/or access easement to the Township owned parcel on Jackson Lane (UPI #53-1M-21) and a pedestrian crossing, per PENNDOT regulations, across Hershey Mill Road to Tanglewood Drive.
17. Please contact our office 48-hours in advance of any stormwater management testing.
18. Please include the Township in any pre-application meetings and/or submissions to the Chester County Conservation District and/or PADEP.
19. It may be appropriate to remove the existing driveway and stream crossing if Lot 15 will be accessed via the proposed road.
20. It is unclear why 16- and 20-foot setbacks from the right-of-way are indicated.
21. The following items are required for a sketch plan (§205-27.B):
 - a. Graphic scale;
 - b. Proposed water supply and sewage features; and
 - c. Soil types.

Should you have any further questions or comments, please contact the undersigned.

Sincerely,

PENNONI



Nathan M. Cline, PE
Township Engineer

cc (via e-mail): Derek Davis, Township Manager
Mark Miller, Public Works
Bill Christman, Township Solicitor
Michael D. Hartman, PE, dH Enterprises
Grove Meadow Developers LLC

SLIP SLOPES - 15-25%
 SLIP SLOPES - 25%
 MATERIALS



ENTIREMENTS

2815 PENN AVENUE
 WESTLAWN, PA
 610-927-4242

DATE: 8/22/22

DESCRIPTION: 30% GROUNDWATER DESIGN & MANAGEMENT PLAN

Date	Revisions

UNSATURATED OPEN SPACE
 1.12 ACRES

QUADRANT OPEN SPACE
 0.39 ACRES (33% MIN)

PROPOSED OPEN SPACE
 1.51 ACRES

OPEN SPACE DEVELOPMENT OPTION
 REQUIRED OPEN SPACE: 1.70 ACRES

MAX. 80% COVERAGE
 MAX. BLDG. COVERAGE
 35%
 25%
 35%
 15%
 35%
 15%
 25%
 35%
 15%

FRONT YARD
 35 FT. CLEARANCE
 5 FT. AVENUE
 25 FT. AVENUE
 15 FT. SIDEWALK

LOW DENSITY RESIDENTIAL DISTRICT (R-2)
 LOT AREA
 1.0 ACRE
 60 FT. (AT STREET LINE)
 45 FT. (MINIMUM)
 15 FT. (MINIMUM)
 1.0 ACRE

PROPOSED DENSITY:
 0.84 UNITS/ACRE
 0.84 UNITS/ACRE
 1.0 UNITS/ACRE
 1.0 UNITS/ACRE
 1.0 UNITS/ACRE
 1.0 UNITS/ACRE
 1.0 UNITS/ACRE
 1.0 UNITS/ACRE

PROPOSED DEVELOPMENT
 DATE: 8/22/22

SCALE: 1"=800'

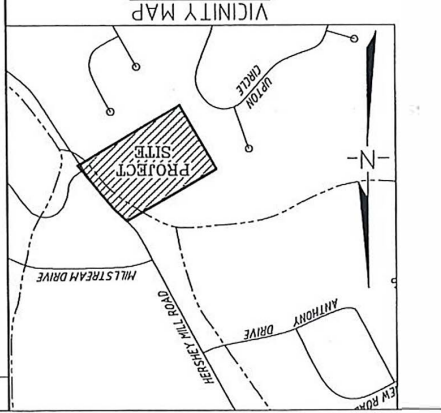
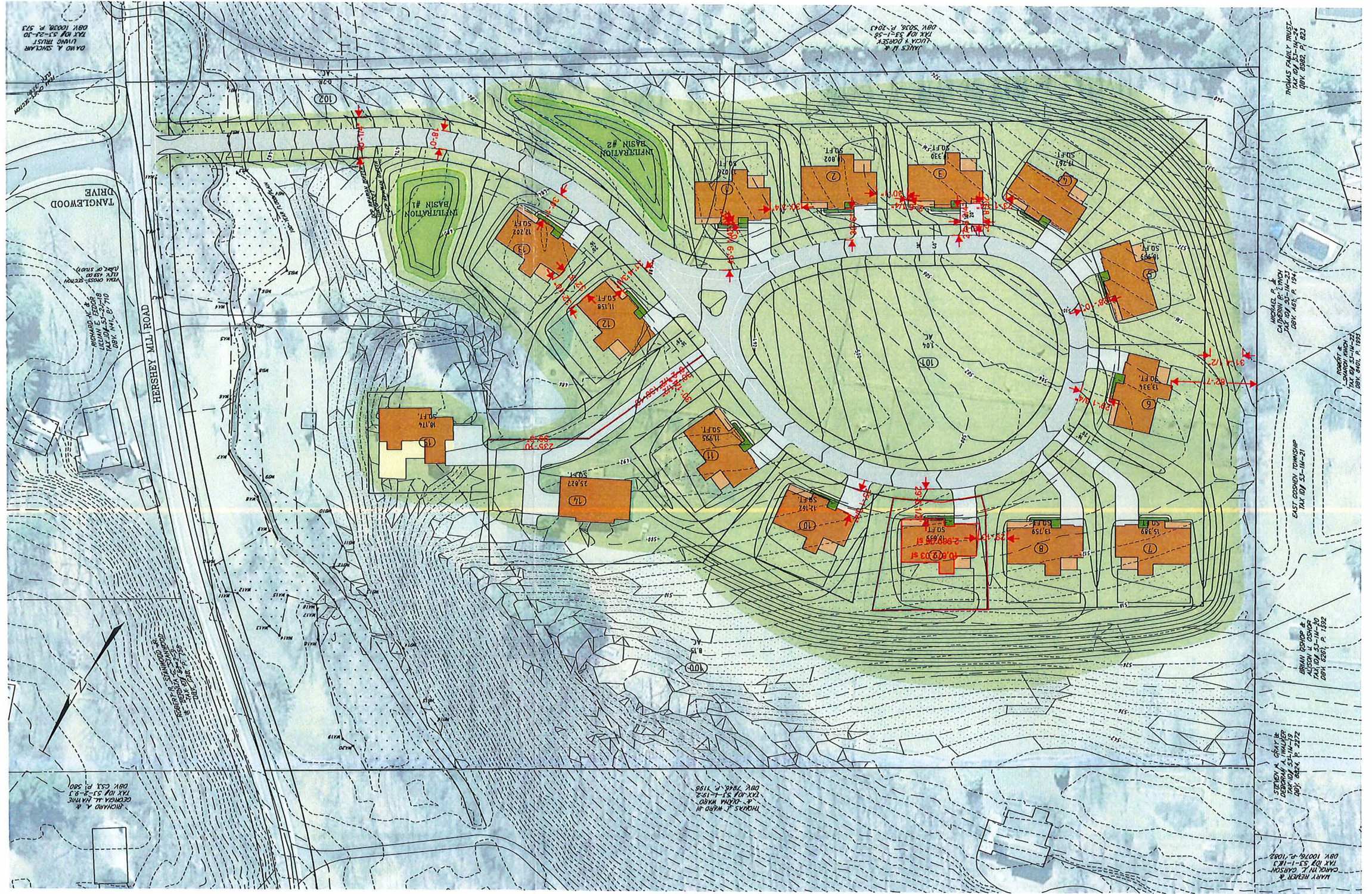

MEMO

Date: September 27, 2022
From: Derek Davis, Township Manager
To: Planning Commission
Re: Noise Ordinance Standards in Zoning Ordinance

A few months back, the Board of Supervisors began exploring changes to the noise ordinance. After several meetings, we have come up with a new combined Noise/Nuisance Ordinance that was tweaked in the following ways.

- A limit on the ability to request noise waivers to four (4) per year
- Making sure noise waivers are request at less fourteen (14) days prior to the event
- Adding “toxic chemicals” as a nuisance/health hazard
- Tweaking times of day for certain noise-related activity in residential neighborhoods as well as a slight change in decimal levels.

The board voted to advertise the attached ordinance.

Normally, a noise and nuisance change with a stand-alone ordinance would not be brought to the Planning Commission, but, part of this change is taking all noise standards out of the Zoning Ordinance. In speaking with our solicitor, it is very rare for a municipality to have noise standards in zoning and it is even rarer to have noise standards in two separate areas of the code. It makes it confusing for those looking to comply with noise standards.

Please review the attached language. As far as a path forward, we plan to bring this back to the Planning Commission at the November meeting with the letter from Chester County, which we do not have yet. This memo was to simply introduce the topic.

The ordinance is attached and Sections 2-7 (starting at the bottom of page 12) reference the changes in the zoning code. As you will see, as far as the Zoning Ordinance, which is the purview of the Planning Commission, all of the changes to the code are a simple deletion of any mention of noise standards.

**EAST GOSHEN TOWNSHIP
CHESTER COUNTY, PENNSYLVANIA**

Ordinance No. _ _ _ _ _

AN ORDINANCE OF THE TOWNSHIP OF EAST GOSHEN, CHESTER COUNTY, PENNSYLVANIA, REPEALING CHAPTER 156 OF THE EAST GOSHEN TOWNSHIP CODE OF ORDINANCES, TITLED “NOISE”, AND REPLACING IT WITH A NEW CHAPTER 156, TITLED “NOISE AND NUISANCES”, IN ORDER TO EFFECTIVELY REGULATE NOISE AND NUISANCE DISTURBANCES IN THE TOWNSHIP; TO REMOVE NOISE REGULATIONS FROM THE EAST GOSHEN TOWNSHIP ZONING ORDINANCE; AND TO CLARIFY NOISE AND NUISANCE STANDARDS FOR SPECIFIC PRINCIPAL USES. EFFECTIVE FIVE DAYS FROM ENACTMENT.

BE IT ENACTED AND ORDAINED by the Board of Supervisors of East Goshen Township that the East Goshen Township Code of Ordinances, as amended, is hereby further amended as follows:

SECTION 1. Chapter 156 of the Code of Ordinances, titled “Noise”, is hereby repealed and replaced with the following:

Chapter 156 Noise and Nuisances

Article I – Noise

§ 156-1 Title.

This chapter shall be known and may be cited as the "East Goshen Township Noise Ordinance."

§ 156-2 Purpose; intent; authority.

- A. Excessive sound is a hazard to the public health, safety, and welfare and to the quality of life of the residents of East Goshen Township, interfering with the quiet enjoyment of residential and public property and the operation of businesses.
- B. It is the policy of the Board of Supervisors to prevent, to control, or to mitigate environmental factors including noise pollution that may jeopardize the health, safety, or welfare of Township residents and businesses.
- C. The Township is empowered to define conduct that constitutes disturbing the peace by § 1527 of the Second Class Township Code, 53 P.S. § 66527, to abate and to prohibit

nuisances on private and public property pursuant to § 1529 of the Second Class Township Code, 53 P.S. § 66529, and to provide for enforcement of noise pollution ordinances by summary offense by § 1601(c.1)(2) of the Second Class Township Code, 53 P.S. § 66601(c.1)(2).

§ 156-3 Establishing limits on noise.

All sound exceeding the limits established hereinbelow are hereby declared to be a public nuisance, and may be abated by administrative or judicial proceedings, fines, and penalties herein provided.

A. Limits established.

- (1) No person shall operate or cause to be operated on private or public property any source of continuous sound (that is, any sound which is static, fluctuating, or intermittent with a recurrence greater than one time in any fifteen-second interval) in such a manner as to create a sound level that exceeds the limits set forth in the following table for the land use of the property receiving the sound, as measured at or within the boundary of the said receiving property.

Receiving Land Use Category	Time	Sound Level Limit (dBA)
Residential, public space, open space, agricultural, or institutional	7:00 a.m. to 7:00 p.m.	65
	7:00 p.m. to 7:00 a.m.	55
Commercial or business	7:00 a.m. to 10:00 p.m.	70
	10:00 p.m. to 7:00 a.m.	65
Industrial	At all times	75

- (2) The proper designation of "receiving land use category" shall be determined by the Township representative taking the sound measurement for the purposes of enforcement of these provisions.

B. Correction for character of sound.

- (1) For any source of sound which emits a pure tone, the maximum sound level limits set forth in the above table shall be reduced by five dBA.
- (2) For any source of sound which emits an impulsive sound (a sound of short duration, with an abrupt onset and rapid decay and an occurrence of not more than one time in any fifteen-second interval) the maximum sound level shall not

exceed 20 dBA over the ambient sound level, regardless of time of day or night or type of receiving land use.

C. Measurement of sound.

- (1) For the purpose of measuring sound to determine compliance with the provisions of this chapter, test equipment, methods, and procedures shall conform to the latest approved standards of the American National Standards Institute (ANSI), or equivalent entity as may be identified by the Board of Supervisors.
- (2) Test equipment shall be operated in accordance with the manufacturer's instructions, specifically including calibration requirements as necessary to assure an accurate measurement.
- (3) The measurement of the sound shall be taken at or beyond the property line of the property from which the sound being measured is emanating.

D. Noise sources defined as nuisances.

- (1) The following sources of noise are hereby defined as public nuisances and subject to control by the Township, regardless of decibel level:
 - (a) A domesticated animal that makes a noise continuously or persistently for a period of 15 minutes or more in such a manner as to disturb persons beyond the property line of the property whereupon such animal is kept.
 - (b) The operation, playing, or permitting of operation or playing of any musical instrument, radio, television, sound amplifier, audio equipment, or similar device between the hours of 9:00 p.m. and 8:00 a.m. in such a manner as to disturb persons beyond the property line of the property upon which such devices are located.
 - (c) Performing any construction operation or operating or permitting the operating of any tools or other equipment used in construction, drilling, blasting, demolition, excavation, extraction of stone, or other such activities, except between the hours of 7:00 a.m. and 7:00 p.m., prevailing time, Monday through Friday, between the hours of 9:00 a.m. and 5:00 p.m., or at any time on Sunday.
 - (d) The operation of an internal combustion engine in such a manner as to disturb persons beyond the property line of the property upon which the engine is located.
 - (e) The operation or permitting of operation of any mechanically powered saw, drill, sander, grinder, lawn or garden tool, or similar device used out of doors between the hours of 9:00 p.m. and 7:00 a.m. in such a manner to disturb persons beyond the property line of the property upon which such device is being operated.

- (2) In addition to the above, it is hereby declared to be a nuisance and shall be unlawful for any person, firm, or business entity to make, cause, or allow to be made or caused upon a property owned, occupied, or controlled by him or it any excessive noises or sounds by means of vehicles, machinery, equipment (including sound amplification equipment and musical instruments), or by any other means or methods which are physically annoying to the comfort of any reasonable person or which are so harsh, prolonged, unnatural, or unusual in their use, time, and place as to occasion physical discomfort or which are otherwise injurious to the lives, health, peace, and comfort of the inhabitants of the Township.

§ 156-4 Exceptions to noise limits.

The following noise sources are hereby exempted from the maximum permissible sound levels provided hereinabove and are furthermore deemed not to be nuisances:

- A. Devices used to alert persons to the existence of an emergency.
- B. Noise associated with emergency work to provide electricity, water, or other utilities when the public health or safety is at risk.
- C. Noise caused by the operation of snow removal and other emergency equipment.
- D. Hand-held power tools and yard maintenance equipment operated on a residential property between the hours of 7:00 a.m. and 9:00 p.m.
- E. Noise caused by construction activity between the hours of 7:00 a.m. and 7:00 p.m., Monday through Friday and between 9:00 a.m. and 5:00 p.m. on Saturday.
- F. Noise attributable to agricultural operations.
- G. Public events authorized by the Township.
- H. Noise from trains.
- I. The unamplified human voice.
- J. Private events for which a waiver under § 156-7 has been granted.

§ 156-5 Enforcement; violation and penalties.

- A. Any person or business entity who or which shall violate any of the provisions of this chapter shall, upon summary conviction thereof in an action brought before a magisterial district judge in the manner provided for the enforcement of summary offenses under the Pennsylvania Rules of Criminal Procedure, be punishable by a fine of not less than \$100 nor more than \$1,000, plus costs of prosecution and, in default of such fine and costs, by imprisonment for a term not exceeding 30 days. Each violation of any of the provisions of this chapter shall be deemed to be a separate and distinct offense. A summary citation under this Chapter may be filed by any Township law enforcement officer, zoning officer, code enforcement officer, Township Manager, or any other person designated by the Board of

Supervisors.

- B. In addition to the above, the Township may institute an action for injunctive relief to prohibit or abate any activity in violation of the provisions of this chapter.

§ 156-6 **Other remedies.**

Nothing in this chapter shall be construed to impair any cause of action or legal remedy thereof of any person or the public for injury to or damage arising from the emission or release into the atmosphere or ground from any source whatsoever of noise in such a place or manner, or at such levels which may give rise to such cause of action.

§ 156-7 **Waivers.**

- A. No more than four (42) times in any calendar year, applicants may request a waiver from any of the parameters specified herein upon demonstrating evidence of the following, as determined at the sole discretion of the Township Manager:
- (1) The temporary operation or causation of such sound, under the circumstances, will not severely jeopardize the health, welfare or safety of the citizens of East Goshen Township;
 - (2) The denial of such a permit will impose excessive hardship on the applicant, the community, or other persons;
 - (3) The operation will not have an adverse effect on contiguous land use; and
 - (4) The operation will not exceed 30 days.
- B. Requests shall be submitted to the Township Manager or his/her designee and shall include the time, duration and reason for the requested waiver. ~~The request should include a list of the names and addresses of all properties within 500 feet of the property upon which the waiver is requested.~~ The request should be submitted at least seven-fourteen (714) days prior to the commencement of the noise source, unless such advance notice is impossible or impracticable under the circumstances.
- C. The fee for a waiver request shall be set forth from time to time by resolution of the Board of Supervisors.
- D. Waivers granted by the Township Manager or his/her designee shall be issued in writing, may contain conditions and restrictions in order to ensure that the intent of this Chapter is implemented, and shall be kept on the premises upon which the waiver is in effect for the duration specified.
- E. Upon the granting of a waiver, the Township shall send notice to all properties within 500 feet of the subject property as soon as practicable.
- F. Failure to abide by the terms of this Chapter, or the conditions and restrictions imposed

upon the granting of a waiver, may result in the revocation or suspension of the waiver, as well as a one-year ban on obtaining further waivers from the provisions of this Chapter.

Article II – Nuisances

§ 156-8 Title.

This chapter shall be known as the "East Goshen Township Nuisance Ordinance."

§ 156-9 Definitions and word usage.

- A. The following words, when used in this chapter or any accompanying resolution, shall have the meaning ascribed to them in this section, except in those incidences where the context clearly indicates a different meaning:

ABANDONED OR JUNKED MOTOR VEHICLES

Any vehicle in a nonserviceable or nonoperational condition, or without having both a current inspection sticker and current registration plate.

BAMBOO

Any monopodial (running) tropical or semi-tropical grasses from the genera Bambusa, including, but not limited to, Bambusa, Phyllostachys, Fallopiia and Pseudosasa, as well as common bamboo, golden bamboo, arrow bamboo, and Japanese bamboo.

BAMBOO OWNER

Any property owner and/or resident, corporation and/or other entity who has planted and/or grows bamboo, or who maintains and/or cultivates bamboo on his/her/its property, or who permits bamboo to grow or remain on any property in East Goshen Township, even if the bamboo has spread from an adjoining property. Any property owner and/or resident, corporation and/or other entity owning, residing, occupying or doing business on property on which bamboo is found shall be considered a bamboo owner. A property owner and/or resident, corporation and/or other entity will not be considered to be a bamboo owner if:

- (1) He/she/it has provided satisfactory proof to East Goshen Township that, within a reasonable period of time not to exceed 60 days after discovering the encroachment of bamboo onto the subject property from an adjoining or neighboring property, he/she/it advised the owner of such property of his/her/its objection to the encroachment of the bamboo; and
- (2) He/she/it has initiated steps for the removal of the bamboo from the property, including remedies at law.

NUISANCE

The unreasonable, unwarrantable, or unlawful use of or activity on any public or private property which causes injury, damage, hurt, inconvenience, annoyance or discomfort to any person or resident in the legitimate enjoyment of his reasonable rights of person or property. This shall include any activity, condition, structure or improvement which shall constitute a threat or potential threat to the health, safety, or welfare of the citizens of the Township.

OWNER

The actual person owning, leasing, occupying or having charge of any premises within the Township, whether individual, partnership, association or corporation.

PERSON

Every natural person, association, partnership, firm, club, society, company, corporation or any organization of any kind. Whenever used in connection with prescribing or imposing a penalty, or both, the term as applied to a partnership shall include the individual partners, or any of them, and as applied to corporations or associations shall include the individual officer(s) thereof.

SUPERVISORS

The Board of Supervisors of East Goshen Township, Chester County, Pennsylvania.

TOWNSHIP

East Goshen Township, Chester County, Pennsylvania.

- B. For the purposes of this chapter, the single shall include the plural, and the masculine shall include the feminine and the neuter.

§ 156-10 Health hazards and nuisances prohibited.

It shall be unlawful for any person to create or maintain any condition, activity or use upon their property which could directly or indirectly cause a nuisance or health hazard to residents of the Township. While not intended to be a comprehensive list, the establishment, maintenance, operation or continuance of any of the following, at any time within the Township, is hereby declared to be a nuisance under the terms of this chapter:

- A. The maintenance, storage or accumulation of the following:
 - (1) Garbage or rubbish;
 - (2) Junk material, including, but not limited to, unused or abandoned machinery, equipment or appliances, and all forms of waste and refuse of any type of materials, including, but not limited to, toxic chemicals, scrap metal, glass, industrial waste or other similar materials; and
 - (3) Any other materials which are conducive to the harboring of vermin, or otherwise cause a potential health hazard or nuisance.
- B. The maintenance, storage or accumulation of one or more abandoned or junked motor vehicles.
- C. The ownership or maintenance of abandoned or neglected buildings, structures, sidewalks or premises which shall pose or constitute any of the following conditions or hazards:
 - (1) A fire hazard;

- (2) A danger of infestation by vermin;
 - (3) An area, building or condition which is or which might potentially serve as an area of play or general attraction for children, or the public in general;
 - (4) Buildings, structures, sidewalks or premises, or parts thereof, which have been damaged by fire, wind or other causes so as to become dangerous to life or safety of the occupants or to others in the vicinity;
 - (5) Buildings, structures, sidewalks or premises, or parts thereof, which have become or are so dilapidated, decayed or unsafe that they are unfit for human habitation or are likely to cause injury to occupants or to others in the vicinity;
 - (6) Buildings or structures having inadequate facilities for egress in case of fire or panic, or those having insufficient stairways, fire escapes or other means of access and egress;
 - (7) Buildings, structures, sidewalks or premises, or parts thereof, which are in such condition that they may fail, collapse, break down, or otherwise cause damage to property or injury to members of the public;
 - (8) Allowing or permitting any excavation, material excavated or obstruction on or joining any highway, street or road, to remain opened or exposed without the same being secured by a suitable barricade, a temporary fence or other protective materials; and
 - (9) Any other condition which the Supervisors shall deem to be a health hazard, potential health hazard, or nuisance.
- D. The draining or flowing, or allowing to drain or flow, whether natural or artificial, of any foul or offensive water or drainage from any dwelling, sink, bathtub, wash stand, lavatory, water closet, swimming pool, privy, or cesspool of any kind or nature whatsoever, or any foul or offensive drainage of any kind, from any property into or upon any adjoining property, or onto or along any public highway, road, street, avenue, lane or alley.
- E. The burning of garbage, tires or other tar products.
- F. Permitting or allowing any well or cistern to be, or remain, uncovered.
- G. Permitting the growth of any grass, weed, noxious weeds or any vegetation whatsoever, to conceal any rubbish, garbage, trash or any other violation of this chapter.
- H. Pushing, shoveling or otherwise depositing snow upon the cartway or traveled portion of any public highway, road or street which is maintained by the Township or by the Commonwealth of Pennsylvania, and allowing the same to remain thereon.
- I. The establishment, maintenance, carrying on or permitting of any use or activity which is dangerous, injurious, offensive or damaging to the property of others, or which prevents the

reasonable use, comfort or enjoyment of the property of others by reason of flames, odor, smoke, fumes, dust, gas, noise, dirt, vibration or emission of electromagnetic waves. In determining the offensive or damaging nature of any of the aforesaid items, the Township is not required to make quantitative measurements by instrumentation or other testing, but, instead, may utilize the reasonable and substantial determinations of affected individuals, property owners or occupiers, as well as testimony of the Supervisors, or other persons authorized by the Township.

- J. The setting, maintenance, operation, conduct or permitting of the establishment and maintenance of fire, combustion or manufacturing, or commercial or other process which is or shall be accompanied by constant, periodic or occasional emission of smoke, odor, sparks, ash particles, burned sawdust and debris, or the creation and spreading of ash, debris, poison and like materials on surrounding or adjacent property to the annoyance, disturbance or detriment of surrounding property owners, residents, passersby or the traveling public.
- K. The storing of gasoline, kerosene or other petroleum products in excess of 5,000 gallons, except by gasoline service stations or petroleum products companies.
- L. Removing or altering the embankment of a stream so as to alter the natural flow of the stream.
- M. Interfering with the flow of a stream, creek or other waterway, by means of a dam, construction or otherwise.
- N. The permitting, growth or maintenance of ragweed, chicory, thistle, goldenrod, poison ivy, poison oak, sumac, or other similar vegetation, in such a manner that it extends or borders upon or overhangs any street, roadway, sidewalk or other public place.
- O. The permitting, growth or maintenance of any grass, weeds or other such vegetation, not edible or planted for some useful or ornamental purpose, so as to exceed a height of six inches. Excluded from this subsection are wooded areas and open fields or acreage to within 100 feet of any building or structure.

§ 156-11 **Bamboo.**

East Goshen Township has determined that the planting, cultivating and growing of certain running plants, particularly those plants commonly referred to as "bamboo," within East Goshen Township has a negative impact on the health, safety and welfare of the citizens of East Goshen Township and the public at large, as the uncontrolled planting, cultivating and growth of said bamboo plants results in the destructive spread of said plants onto private and public property and thereby constitutes a nuisance within East Goshen Township. East Goshen Township has therefore determined that is in the best interests of the citizens of East Goshen Township and the public at large to control the planting, cultivating and/or growing said bamboo plants within East Goshen Township, primarily by prohibiting the future planting, cultivating and/or growing said bamboo plants within East Goshen Township, and by requiring the use of barriers to prevent the invasive spread of existing bamboo plants within East Goshen Township.

- A. For purposes of this chapter, bamboo found growing upon a property shall constitute presumptive evidence that the bamboo was planted, cultivated and/or grown by, and/or with the consent of, the subject property owner, tenant, and/or any other individual, entity or corporation then having control of and/or over the subject property, subject to the definition of "bamboo owner," above.
- B. Prohibition. Upon the effective date of this section, the planting, cultivating and/or growing of bamboo shall be prohibited within the Township. No persons, property owners, tenants, and/or other individuals, entities, and/or corporations having control of and/or over any property located within the Township shall plant, cultivate, and/or cause to grow any bamboo on any real property within the Township. Any person who plants, cultivates, and/or grows, and/or causes or allows to be planted, cultivated and/or grown, bamboo within the Township shall be deemed to be in violation of this chapter and shall be subject to such penalties as are set forth herein.
- C. This section shall not be deemed to alter or abrogate any rights at common law, or otherwise, that any persons, property owners, tenants, and/or other individuals, entities, and/or corporations may have to recover the cost of removal of any bamboo found on their own property that has encroached from a neighboring property.
- D. Exceptions. Notwithstanding the prohibitions set forth in § 156-11.B, above, upon the effective date of this section, persons, property owners, tenants, and/or other individuals, entities, and/or corporations having control of and/or over any property located within the Township shall be permitted to plant, cultivate, and/or cause to grow bamboo on any real property within the Township only if:
 - (1) The root system of such bamboo is entirely contained within an above-ground-level planter, barrel or other vessel of such design, material, and location as to prevent completely the spread of growth of the bamboo root system beyond the container in which it is planted; or
 - (2) The root system of such bamboo is contained within and/or restricted by a barrier, constructed in accordance with the following specifications, and installed by an experienced installer with certification provided to the Township:
 - (a) The barrier itself shall be composed of a high-density polypropylene or polyethylene, with a thickness of 40 mils, or more;
 - (b) Each portion or sheet of the barrier shall be secured or joined together by the use of stainless steel clamps or stainless steel closure strips designed to be used with such barriers;
 - (c) The barrier shall be installed not less than 30 inches deep;
 - (d) The barrier shall be circular or oblong shaped;
 - (e) Not less than three inches of the barrier shall protrude above ground level around the entire perimeter of the bamboo; and

- (f) When installed, the barrier shall slant outward from the bottom to top.
 - (3) Any and all bamboo existing pursuant to this shall, at all times, be located, trimmed and maintained so that no bamboo, or any part thereof, shall be within 10 feet of any property line, curb, and/or sidewalk, nor within 40 feet of any roadway, cartway, street, storm sewer, sanitary sewer and/or public water facilities within the Township.
- E. Any bamboo that has been planted or otherwise permitted to grow on any property within the Township prior to the effective date of this section may remain on such property subject to compliance with the following:
- (1) The bamboo shall not be within 10 feet of any property line, curb, and/or sidewalk, or within 40 feet of any roadway, cartway, street, storm sewer, sanitary sewer and/or public water facilities within the Township.
 - (2) Any bamboo owner whose property contains bamboo that is located within 10 feet of any property line, curb, and/or sidewalk, or within 40 feet of any roadway, cartway, street, storm sewer, sanitary sewer and/or public water facilities within the Township shall remove such bamboo and shall abate the growth of such bamboo so that it is not within 10 feet of any property line, curb, and/or sidewalk, nor within 40 feet of any roadway, cartway, street, storm sewer, sanitary sewer and/or public water facilities within the Township.
 - (3) A bamboo owner shall further be responsible to ensure that any bamboo planted and/or growing on the property of the bamboo owner prior to the effective date of this section is maintained such that it does not encroach or grow upon any adjoining or neighboring property or properties, including all public property and public rights-of-way. If the Township determines that any such bamboo, or part thereof, has been allowed to encroach, grow upon, extend roots across, and/or extend branches, stalks and/or leaves over any public right-of-way and/or any private property not owned by and/or in the possession of the bamboo owner, the bamboo owner shall be required to comply with the provisions of § 156-11.D above.
- F. Replanting prohibited. Any bamboo either planted or caused to be planted or existing on a property prior to the effective date of this section may not be replanted or replaced in kind once such running bamboo is or has become, for any reason, dead, destroyed, uprooted or otherwise removed, unless such replanting is consistent with the provisions of § 156-11.D above.

§ 156-12 Notice to abate nuisances.

Whenever a condition constituting a nuisance or health hazard is permitted or maintained, the Supervisors, or persons authorized by the Township, may give the owner of the property in which said nuisance is located, and any other person permitting the maintenance of such a nuisance, written notice to completely remove, repair or abate the same. Said notice shall require such removal, repair, or abatement within 15 days of the date of such notice. Said notice shall be

served in one of the following matters:

- A. By personal delivery;
- B. By certified mail, return receipt requested, to the last known address of the owner;
- C. By posting a copy of the notice upon the premises; or
- D. By publishing a copy of the notice in a local paper of general circulation within East Goshen Township, Chester County, Pennsylvania, once a week for three consecutive weeks.

§ 156-13 Violations and penalties.

Any person or business entity who or which shall violate any of the provisions of this chapter shall, upon summary conviction thereof in an action brought before a magisterial district judge in the manner provided for the enforcement of summary offenses under the Pennsylvania Rules of Criminal Procedure, be punishable by a fine of not less than \$100 nor more than \$1,000, plus costs of prosecution and, in default of such fine and costs, by imprisonment for a term not exceeding 30 days. Each violation of any of the provisions of this chapter shall be deemed to be a separate and distinct offense. When a violation continues beyond the time limit as may be set forth in an NOV, each day that a violation continues beyond the time limit shall be deemed a separate and distinct offense. When a person or entity who or which has been issued an NOV is found again to be in violation of this chapter and issued another NOV within 12 months of the previous NOV, the fine shall be double the amount of the previous fine up to a maximum fine of \$1,000 for each separate and distinct offense.

§ 156-14 Abatement of nuisances by Township.

In addition to, or instead of, invoking the penalties set forth in the preceding section, the Township, or persons authorized by the Township, may, in the event of any continued violations of this chapter, enter upon the offending premises and remove, repair or alter any nuisance, hazard or dangerous structure or condition on such property, or otherwise abate any identified nuisance or health hazard. Further, the Township may collect the costs of such removal or abatement, together with any penalty and costs as granted in summary proceedings, from the owner of the property or premises. The actual costs of such removal, together with the penalties, costs and reasonable attorney's fee, shall be a lien upon such premises, and may be enforced against the property and recovered by the Township in the manner prescribed for the levying and collecting of municipal liens under appropriate law.

§ 156-15 Injunctive relief.

The Township may, by means of a complaint in equity or other appropriate filing, compel the owner of a structure or premises declared a nuisance to comply with the terms of any notice of violation, or seek any other appropriate relief, including an injunction, from any court of competent jurisdiction.

SECTION 2. Section 240-24 of the East Goshen Township Zoning Ordinance, titled “General Performance Standards”, is hereby amended to delete Subsection C, titled “Noise Control”, as

well as the subsection’s constituent paragraphs, and is replaced with the following:

C. Reserved.

SECTION 3. Section 240-24 of the East Goshen Township Zoning Ordinance, titled “General Performance Standards”, is hereby amended to delete subsection D, titled “Vibration Control”, and is replaced with the following:

D. Reserved.

SECTION 4. Section 240-31 of the East Goshen Township Zoning Ordinance, titled “Conditional Uses; Additional Standards for Specific Principal Uses”, Subsection 240-31.C(3)(h)[2][b][ii][C], is hereby repealed and replaced with the following:

[C] A study demonstrating compliance with the noise standards in Chapter 156 of the Code of Ordinances. In instances where there are multiple carriers or multiple equipment boxes proposed to be built on one site, the applicant must demonstrate that the cumulative noise from all carriers’ equipment shall comply with the noise standards of Chapter 156 of the Code of Ordinances;

SECTION 5. Section 240-31 of the East Goshen Township Zoning Ordinance, titled “Conditional Uses; Additional Standards for Specific Principal Uses”, Subsection 240-31.C(3)(h)[3][c][ii][B]{3}, is hereby repealed and replaced with the following:

{3} A study demonstrating compliance with the noise standards in Chapter 156 of the Code of Ordinances. In instances where there are multiple carriers or multiple equipment boxes proposed to be built on one site, the applicant must demonstrate that the cumulative noise from all carriers' equipment shall comply with the noise standards in Chapter 156 of the Code of Ordinances;

SECTION 6. Section 240-31 of the East Goshen Township Zoning Ordinance, titled “Conditional Uses; Additional Standards for Specific Principal Uses”, Subsection 240-31.C(3)(p)[6], is hereby repealed and replaced with the following:

[6] See the general performance standards of Article V and the noise and nuisance regulations of Chapter 156.

SECTION 7. Section 240-31 of the East Goshen Township Zoning Ordinance, titled “Conditional Uses; Additional Standards for Specific Principal Uses”, Subsection 240-31.C(3)(aa)[14], is hereby repealed and replaced with the following:

[14] All uses shall be conducted in compliance with applicable governmental regulations, including the general performance standards of this chapter and the noise and nuisance regulations of Chapter 156.

SECTION 8. If any sentence, clause, section or part of this Ordinance is for any reason found to be unconstitutional, illegal or invalid, such unconstitutionality, illegality or invalidity shall not affect or impair any of the remaining provisions, sentences, clauses, sections or parts hereof. It is hereby declared as the intent of the Board of Supervisors that this Ordinance would have been adopted had such unconstitutional, illegal or invalid sentence, clause, section or part thereof not been included therein.

SECTION 9. General Code is hereby authorized to make any necessary formatting and numbering changes needed in order for this Ordinance to be made consistent with the formatting and numbering standards applicable to the East Goshen Township Code of Ordinances as published by General Code.

SECTION 10. All Ordinances or parts of Ordinances conflicting with any provision of this Ordinance are hereby repealed insofar as the same affects this Ordinance.

SECTION 11. This Ordinance shall become effective five days after enactment.

ENACTED and ORDAINED this _____ day of _____, 2022.

**BOARD OF SUPERVISORS
EAST GOSHEN TOWNSHIP**

Michele Truitt, Chair

John Hertzog, Vice Chair

Cody Bright, Member

Michael Lynch, Member

David E. Shuey, Member

ATTEST:

Derek J. Davis, Secretary

MEMO

Date: September 27, 2022
From: Duane J. Brady Sr., Zoning Officer
To: Planning Commission
RE: Noise Ordinance Standards in Zoning Ordinance

Zoning Ordinance Sections to be changed or deleted:

**240-24 General Performance Standards Subsection C, titled Noise Control (Existing Language).
(Page 12 Section 2 of MEMO)**

C. Noise control.

(1) No person shall operate or cause to be operated, on private or public property, any source of continuous sound (any sound which is static, fluctuating or intermittent with a recurrence greater than one time in any fifteen-second interval) in such a manner as to create a sound level which exceeds the limits set forth for the receiving land use category in the following table when measured at or within the property boundary of the receiving land use.

Continuous Sound Levels by Receiving Land Use

Receiving Land Use Category	Time
Residential, public space, open space, agricultural or institutional	7:00 a.m. to 10:00 p.m. 10:00 p.m. to 7:00 a.m. plus Sundays and legal holidays
Commercial or business	7:00 a.m. to 10:00 p.m. 10:00 p.m. to 7:00 a.m. plus Sundays and legal holidays
Industrial	At all times

(2) For any source of sound which emits a pure tone, the maximum sound level limits set forth in the above table shall be reduced by 5 dBA. For any source of sound which emits an impulsive sound (a sound of short duration, with an abrupt onset and rapid decay and an occurrence of not more than one time in any fifteen-second interval) the excursions of sound pressure level shall not exceed 20 dBA over the ambient sound pressure level, regardless of time of day or night or receiving land use. Such analysis should be based upon using the fast meter characteristic of a Type II meter, meeting either ANSI specifications S1.4 1971 or a later standard.

(3) The maximum permissible sound levels by the receiving land use category as listed in the previous table shall not apply to any of the following noise sources:

- (a)** The emission of sound for the purpose of alerting persons to the existence of an emergency.
- (b)** Emergency work to provide electricity, water, or other public utilities when public health or safety are involved.
- (c)** Domestic power tools.
- (d)** Explosives and construction operations.

- (e) Agriculture.
- (f) Motor vehicle operations.
- (g) Public celebrations specifically authorized by the Township.
- (h) Surface carriers engaged in commerce by railroad.
- (i) The unamplified human voice.

**240-24 General Performance Standards Subsection D, titled Vibration Control (Existing Language).
(Page 13 Section 3 of MEMO)**

D. Vibration control. Operating or permitting the operation of any device that creates vibration which is above the vibration perception threshold of an individual at or beyond the property boundary of the source, if on private property or at 50 feet from the source or if on a public space or public right-of-way, shall be prohibited. For the purposes of this section, "vibration perception threshold" means the minimum ground- or structure-borne vibrational motion necessary to cause a normal person to be aware of the vibration by such direct means, including but not limited to sensation by touch or visual observation of moving objects.

**240-31 Conditional Use; Additional Standards for Specific Principal Uses, Subsection
C(3)(h)[2][b][ii][C], (Existing Language). (Page 13 Section 4 of MEMO)**

C. Standards for conditional uses and special exception uses and certain permitted-by-right uses.
(3) Specific standards for specific principal uses (including but not limited to conditional uses and special exception uses). Each of the following principal uses shall meet the following additional specific standards. In addition, each conditional or special exception use shall meet the general standards in Subsection C (2). The following specific standards shall be met for the applicable use, unless a more restrictive standard is established by another section of this chapter:

(h) Wireless communications facilities.

(2) Standards for commercial communications antenna erected on a commercial communications support structure. All applicants seeking to construct, erect, relocate or alter a commercial communications support structure shall comply with the following regulations. Applicants seeking to modify and/or co-locate on an existing wireless telecommunications facility or existing wireless support structure that has been previously approved for wireless telecommunications shall not be subject to the conditional use procedures set forth in this section, provided that the modification and/or co-location meet all of the requirements of the Pennsylvania Wireless Broadband Collocation Act, 53 P.S. § 11702.1 et seq., including the definitions of "collocation" and "modification" in such Act. A written narrative that addresses how the applicant will meet each of the regulations listed below shall be submitted with the conditional use application.

(b) Conditional use application.

(ii) Miscellaneous information and reports. The conditional use application shall be accompanied by the following:

(C) A study demonstrating compliance with the noise standards in § 240-24 of this chapter. In instances where there are multiple carriers or multiple equipment boxes proposed to be built on one site, the applicant must demonstrate that the cumulative noise from all carriers' equipment shall comply with the noise standards in this chapter;

240-31 Conditional Use; Additional Standards for Specific Principal Uses, Subsection C(3)(h)[3][c][ii][B]{3}, (Existing Language). (Page 13 Section 5 of MEMO)

C. Standards for conditional uses and special exception uses and certain permitted-by-right uses.
(3) Specific standards for specific principal uses (including but not limited to conditional uses and special exception uses). Each of the following principal uses shall meet the following additional specific standards. In addition, each conditional or special exception use shall meet the general standards in Subsection C (2). The following specific standards shall be met for the applicable use, unless a more restrictive standard is established by another section of this chapter:

(h) Wireless communications facilities.

[3] Standards for commercial communications antenna erected on an existing structure.

[c] All applicants seeking to construct, erect, or locate a commercial communications antenna on an existing structure that has not been previously approved for the installation of commercial communications antenna and their support members shall comply with the following regulations. A written narrative that addresses how the applicant will meet each of the regulations listed below shall be submitted with the conditional use application.

[ii] Conditional use.

[B] Miscellaneous information and reports. The conditional use application shall be accompanied by the following:

- {3} A study demonstrating compliance with the noise standards in § 240-24 of this chapter. In instances where there are multiple carriers or multiple equipment boxes proposed to be built on one site, the applicant must demonstrate that the cumulative noise from all carriers' equipment shall comply with the noise standards in this chapter;

240-31 Conditional Use; Additional Standards for Specific Principal Uses, Subsection C(3)(p)[6], (Existing Language). (Page 13 Section 6 of MEMO)

C. Standards for conditional uses and special exception uses and certain permitted-by-right uses.
(3) Specific standards for specific principal uses (including but not limited to conditional uses and special exception uses). Each of the following principal uses shall meet the following additional specific standards. In addition, each conditional or special exception use shall meet the general standards in Subsection C (2). The following specific standards shall be met for the applicable use, unless a more restrictive standard is established by another section of this chapter:

(p) Junkyard (includes automobile salvage yard).

[6] See the noise or dust regulations of Article V.

240-31 Conditional Use; Additional Standards for Specific Principal Uses, Subsection C (3) (aa) [14], (Existing Language). (Page 13 Section 6 of MEMO)

C. Standards for conditional uses and special exception uses and certain permitted-by-right uses.
(3) Specific standards for specific principal uses (including but not limited to conditional uses and special exception uses). Each of the following principal uses shall meet the following additional specific standards. In addition, each conditional or special exception use shall meet the general standards in Subsection C (2). The following specific standards shall be met for the applicable use, unless a more restrictive standard is established by another section of this chapter:

(aa) Public utility facility and/or public utility building.

[14] All uses shall be conducted in compliance with applicable governmental regulations, including the noise and lighting regulations in this chapter.



One South Church Street
Second Floor
West Chester, PA 19382
T: 610-429-8907
F: 610-429-8918

www.pennoni.com

September 1, 2022

EGOST 00136

Duane Brady, Zoning Officer
East Goshen Township
1580 Paoli Pike
West Chester, PA 19380

**RE: Applebrook Golf Club Turf Maintenance Area
Preliminary/Final Land Development**

Dear Duane:

As requested, we have reviewed the following information, prepared by Chester Valley Engineers, Inc., in connection with the referenced project:

- *"Land Development Plans for Applebrook Golf Club Turf Maintenance Area"* (15 sheets), dated July 26, 2022;
- *"Post-Construction Stormwater Management Report"* dated July 26, 2022; and
- Application and supplemental information.

The applicant, Applebrook Associates, propose to modify maintenance facility by constructing two (2) new maintenance and storage buildings, new storage bins, and associated parking and stormwater management on UPI #53-4-89.1 (93.1 acres). This parcel is owned by the Township, the existing maintenance facility is located within an access and maintenance easement; 2,614 square feet of additional easement area is proposed. Future building expansions are also indicated. The site is located directly south of the intersection of Paoli Pike (SR 2014) and Hibberd Lane, within the I-2 Planned Business, Research, and Limited Industrial District. The lot is by served by on-site water and public sanitary sewer.

The applicant has requested the following waivers:

1. From §205-01 – To permit the submission of a combined preliminary/final plan;
2. From §205-37.C(7) – To permit 12-inch diameter stormwater pipes;
3. From §205-39 – Requiring a traffic study, as no new traffic will be created;
4. From §205-40 – Requiring a water supply study, as no new water supply will be generated; and
5. From §205-38.10.A(1) – Requiring a Historical Resources Impact Assessment.

We offer the following comments:

ZONING

1. For the purpose of this review, we considered the buildings as accessory uses to the golf course; however, they are on separate properties. We recommend that the Zoning Officer/Township Solicitor should review the same; note (§340-30.1(C)(1)(g)) and our additional comment below (No. 11).
2. Per §240-20.B, a perimeter building setback is required due to its proximity to Paoli Pike. However, §240-20.F(1) & §240-20.F(2)(c) indicate the perimeter building setback requirement is not applicable for a planned golf course development. It is unclear if the proposed work is considered a planned golf

course development and thus not required. We recommend that the Zoning Officer/Township Solicitor should review further.

3. Per §240-20.F(3)(c), a front yard setback of 50 feet is required. There appear to be areas where this setback from Hibbard Lane is not met; however, it is unclear if this requirement applies to Hibberd Lane. We recommend that the Zoning Officer/Township Solicitor review further.
4. New structures shall incorporate a complete visual screen for all rooftop structures (except roof-mounted solar panels), including but not limited to, heat pumps, cooling towers and other mechanical equipment. All rooftop structures (except roof-mounted solar panels) shall be screened from view by a single piece of the building structure which is aesthetically compatible in design, materials and color with the building facade, and which is at least equal in height to the highest rooftop structure. (§240-20.H(1))
5. All outdoor storage facilities for fuel, raw materials and products stored outdoors shall be enclosed by a fence of a type, construction and size as shall be adequate to protect and conceal the facilities from any adjacent properties. Fencing shall not only encompass the question of safety, but also of screening, and the screening shall preferably be evergreens. All national Occupational Safety and Health Administration (OSHA) regulations shall be met (§240-24.E(2)).
6. Buffer yards are required to be provided as part of any new or expanded development of a principal commercial use, principal industrial use, townhouse development or apartment development along any lot line that would be contiguous to lot(s) within a residential district. Also, any outside industrial storage area visible from a lot in a residential district shall be separated by a buffer yard from such lot. (§240-27.C(2)). It is unclear if this section is applicable.
7. Landscaped plant screening shall be provided in each buffer yard. This screening shall be composed of mostly evergreen shrubs and trees arranged to form both a low-level and a high-level screen (§240-27.C(3(a))). Supplemental landscaping to the existing vegetation is provided in some areas; as this site is adjacent to the Township Park, we recommend that the Conservancy Board review further.
8. All outdoor storage or truck loading areas shall be completely screened from view from any adjacent public street right-of-way and any residential district which is contiguous to or across the street from the storage or loading areas (§240-27.C(4(a))). Supplemental landscaping to the existing vegetation is provided in some areas; as this site is adjacent to the Township Park, we recommend that the Conservancy Board review further.
9. The parking, loading, ingress and egress areas shall be provided with sufficient lighting for security purposes (§240-27.C(7(a))). A lighting plan was not provided.
10. If the applicant is proposing restrictions, easements and/or covenants for the development, they shall be submitted to the Township for review prior to approval of the final development plans (§240-27.F). If our understanding modifications to existing documents are pending.
11. Note maintenance buildings for storage and maintenance of equipment directly related to the golf course use may be located off site on property contiguous to the golf course, provided that there is direct access to and from the accessory buildings to the golf course over a private street or driveway serving the golf course and a subdivision plan of the off-site property is approved by the Board of Supervisors. (§340-30.1(C)(1)(g)) No further action is required, but it may be appropriate to include this as a note on the plans.

SUBDIVISION AND LAND DEVELOPMENT

12. Soil types should be added to the plans. (§205-27.B(10)).
13. The plans shall clearly indicate the property is owned by East Goshen Township and Applebrook Golf Course has an easement for this portion of the property. (§205-33.B(33)) Further, it is unclear if the Township should be a co-applicant and/or signature blocks provided.
14. Location and elevation of the bench mark to which contour elevations refer (§205-30.B(8)).
15. A certification of ownership shall be signed and notarized by the owner(s) of the property. (§205-33.B(17)).
16. The applicant shall provide the Township with either of the following as appropriate prior to recordation of the final plan: A copy of the letter from the Department of Environmental Protection approving the Act 537 planning module for the project, a copy of the letter from the Department of Environmental Protection approving the exemption from the requirement to prepare the Act 537 planning module, or a copy of the letter from the Department of Environmental Protection approving the Form B waiver for the project (§205-33.B(22)).
17. Such private deed restrictions and/or a statement of any restrictions previously imposed in accordance with §205-33.C(2).

STORMWATER MANAGEMENT

18. The site plan includes a vehicle fueling station which is considered a stormwater hotspot, in addition to a wash station and materials storage. Please include appropriate pretreatment for the proposed infiltration BMP. (§195-15.N(2))
19. The disturbed area appears to be greater than one (1) acre; therefore, an NPDES permit is required. Please include the Township and our office in all correspondence and/or meetings with the Conservation District. (§195-17.A(1)(b)) As the Township owns the property, they may be required to be the applicant or co-applicant.
20. Per recent discussions with the design engineer, they indicated that the stormwater management design is being revised due to soils testing results and a pending revision to one of the buildings. We will review the stormwater management when the revised plans are submitted.

GENERAL

21. The plans appear to an easement or right-of-way from Paoli Pike along the southern portion of site. The proposed administration/maintenance/equipment storage building extends into this area.
22. The plan should clarify Hibberd Lane is a private road.
23. Please indicate the existing well location.
24. Please indicate the existing sanitary sewer connection.
25. An existing septic tank is indicated; please clarify if this is to be removed.
26. The plan is subject to Fire Marshall/Emergency Management review.

Should you have any further questions or comments, please contact the undersigned.

Sincerely,

PENNONI



Nathan M. Cline, PE
Township Engineer

cc (via-email): Derek Davis, Township Manager
Mark Miller, Public Works
Bill Christman, Township Solicitor
Applebrook Associates, c/o Jared Viarengo
Brian Nagle, Esq.
Brett MacKay, PE, Chester Valley Engineers



THE COUNTY OF CHESTER



COMMISSIONERS
Marian D. Moskowitz
Josh Maxwell
Michelle Kichline

Brian N. O'Leary, AICP
Executive Director

PLANNING COMMISSION
Government Services Center, Suite 270
601 Westtown Road
P. O. Box 2747
West Chester, PA 19380-0990
(610) 344-6285 Fax (610) 344-6515

September 21, 2022

Derek Davis, Manager
East Goshen Township
1580 Paoli Pike
West Chester, PA 19380

Re: Preliminary Land Development - Applebrook Golf Club Turf Maintenance Area
East Goshen Township – LD-09-22-17351

Dear Mr. Davis:

A Preliminary Land Development Plan entitled "Applebrook Golf Club Turf Maintenance Area", prepared by Chester Valley Engineers, Inc., and dated July 26, 2022, was received by this office on September 1, 2022. This plan is reviewed by the Chester County Planning Commission in accord with the provisions of Section 502 of the Pennsylvania Municipalities Planning Code. We offer the following comments on the proposed land development for your consideration.

PROJECT SUMMARY:

Location:	the southeast side of Paoli Pike, northeast of North Chester Road
Site Acreage:	93.14
Lots/Units:	1 existing lot
Non-Res. Square Footage:	10,903
Proposed Land Use:	Two building additions
New Parking Spaces:	6
Municipal Land Use Plan Designation:	Greenway/Open Space, and Paoli Pike Corridor
UPI#:	53-4-89.1-E

PROPOSAL:

The applicant proposes the construction of two building additions totaling 10,903 square feet, and six additional parking spaces. The project site, which is served by on-site water and public sewer, is located in the I-2 Planned Business/Research/Limited Industrial/Park/Residential zoning district.

RECOMMENDATION: The County Planning Commission recommends that the issues raised in this letter should be addressed, and all Township issues should be resolved before action is taken on this land development plan.

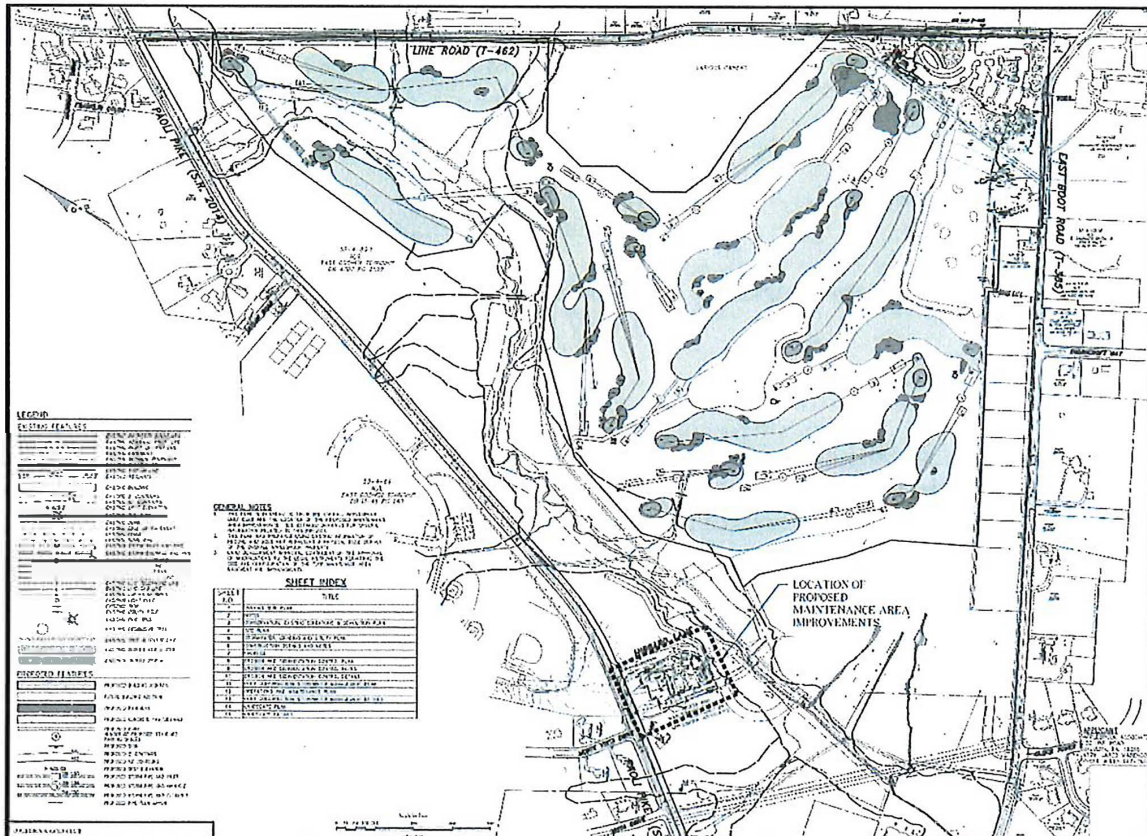
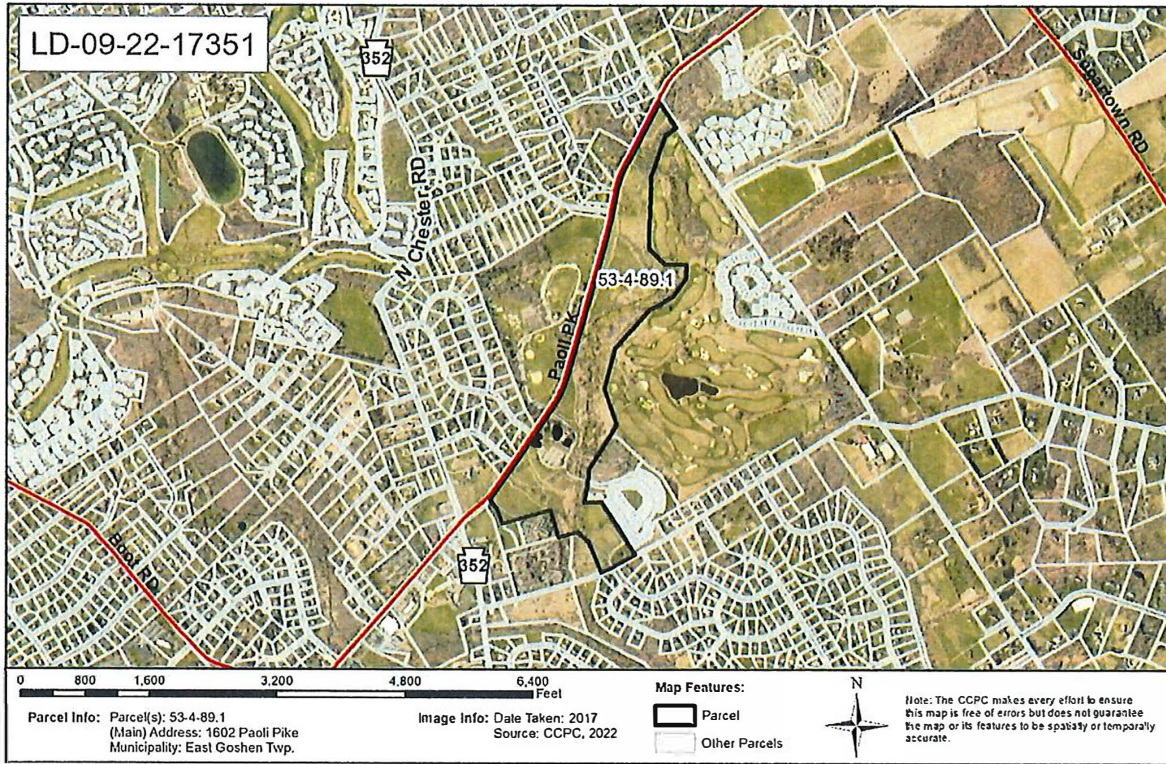

Site Plan Detail, Sheet 1: Applebrook Golf Club Turf Maintenance Area

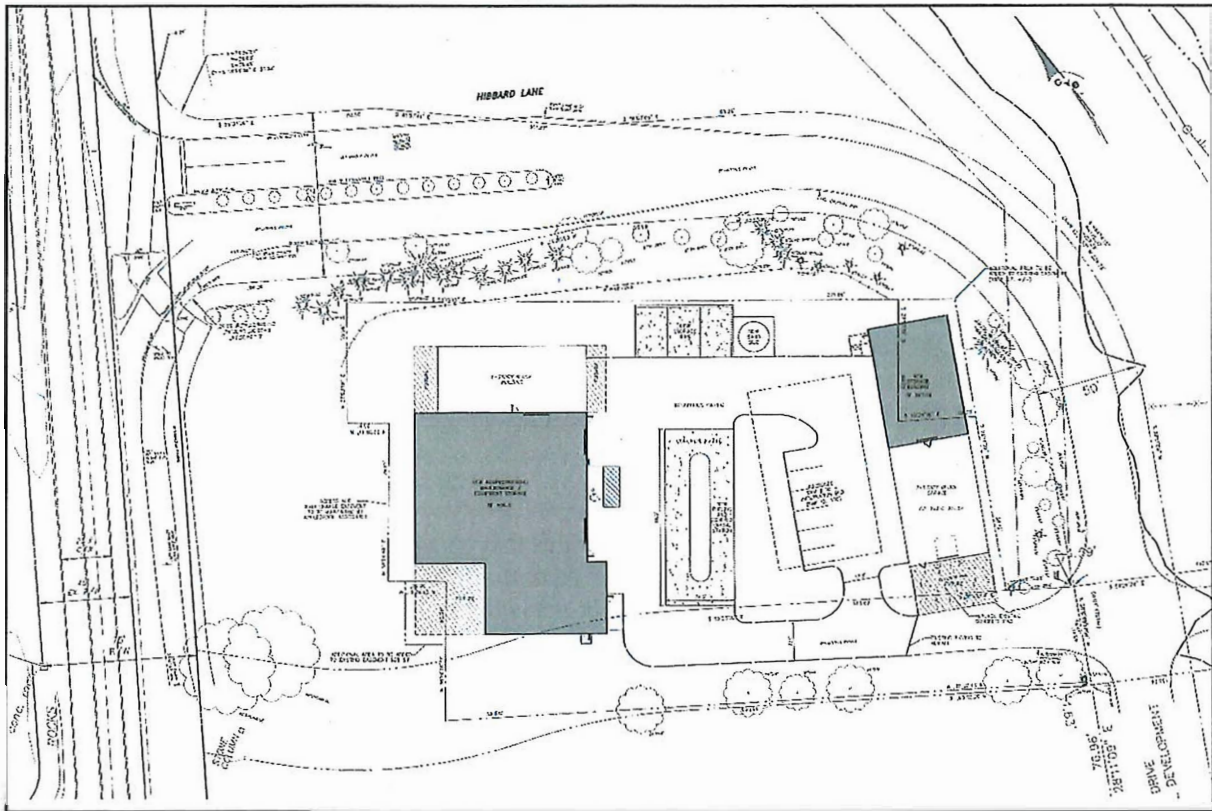

Site Plan Detail, Sheet 4: Applebrook Golf Club Turf Maintenance Area

COUNTY POLICY:

LANDSCAPES:

1. The project site is located within the **Suburban Landscape** and **Natural Landscape** designations of **Landscapes3**, the 2018 County Comprehensive Plan. The vision for the **Suburban Landscape** is predominantly residential communities with locally-oriented commercial uses and facilities, accommodating growth at a medium density that retains a focus on residential neighborhoods, with enhancements in housing diversity and affordability. As an overlay of all other landscapes, the county's **Natural Landscapes** consist of a network of streams, wetlands, floodplains, and forests that are protected by regulations or should be subject to limited disturbance. Conservation practices should protect and restore these natural resources. The proposed land development is consistent with the objectives of the **Suburban Landscape**.

WATERSHEDS:

2. **Watersheds**, the water resources component of **Landscapes3**, indicates the proposed development is located within the Ridley Creek watershed. **Watersheds'** highest priority land use objectives within this watershed are: reduce stormwater runoff, protect vegetated riparian corridors, and protect/enhance water-based recreation, cultural, historic resources and public access. **Watersheds** can be accessed at www.chesco.org/water.

Page: 5

Re: Preliminary Land Development - Applebrook Golf Club Turf Maintenance Area

East Goshen Township – LD-09-22-17351

This report does not review the plan for compliance to all aspects of your ordinance, as this is more appropriately done by agents of East Goshen Township. However, we appreciate the opportunity to review and comment on this plan. The staff of the Chester County Planning Commission is available to you to discuss this and other matters in more detail.

Sincerely,

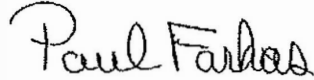
A handwritten signature in black ink that reads "Paul Farkas". The signature is written in a cursive, slightly slanted style.

Paul Farkas
Senior Review Planner

cc: Applebrook Golf Club
Chester Valley Engineers, Inc.
Chester County Health Department
Chester County Conservation District